



Adjustable-length Twist lever for position switch 3SE51/52 Metal lever 100 mm long Plastic roller 19 mm

product brand name	SIRIUS
product designation	actuator for part-turn actuator
product type designation	3SE5
manufacturer's article number	
• of the supplied operating lever	3SE5000-0AA50
suitability for use safety switch	No
General technical data	
product function positive opening	No
shock resistance	
• according to IEC 60068-2-27	30g / 11 ms
vibration resistance	
• according to IEC 60068-2-6	0.35 mm/5g
mechanical service life (operating cycles) typical	15 000 000
reference code according to IEC 81346-2	T
active principle	mechanical
Substance Prohibition (Date)	07/01/2006
Ambient conditions	
ambient temperature	
• during operation	-25 ... +85 °C
• during storage	-40 ... +90 °C
explosion protection category for dust	none
Enclosure	
coating of the enclosure	Other types
Drive Head	
design of the actuating element	Adjustable twist lever, adjustable-length metal lever, plastic roller 19 mm
shape of the switch head	roller
outer diameter of the switch head	19 mm
Installation/ mounting/ dimensions	
mounting position	any
fastening method	screw fixing
design of the interface for safety-related communication	without
Communication/ Protocol	
design of the interface	without
Certificates/ approvals	
General Product Approval	Functional Safety/Safety of Machinery



[Confirmation](#)



[KC](#)



[Type Examination Certificate](#)

Declaration of Conformity

Test Certificates

other



[Type Test Certificates/Test Report](#)

[Confirmation](#)

Further information

Siemens has decided to exit the Russian market (see here).

<https://press.siemens.com/global/en/pressrelease/siemens-wind-down-russian-business>

Siemens is working on the renewal of the current EAC certificates.

Please contact your local Siemens office on the status of validity of the EAC certification if you intend to import or offer to supply these products to an EAC relevant market (other than the sanctioned EAEU member states Russia or Belarus).

Information on the packaging

<https://support.industry.siemens.com/cs/ww/en/view/109813875>

Information- and Downloadcenter (Catalogs, Brochures,...)

<https://www.siemens.com/ic10>

Industry Mall (Online ordering system)

<https://mall.industry.siemens.com/mall/en/en/Catalog/product?mlfb=3SE5000-0AA50>

Cax online generator

<http://support.automation.siemens.com/WW/CAXorder/default.aspx?lang=en&mlfb=3SE5000-0AA50>

Service&Support (Manuals, Certificates, Characteristics, FAQs,...)

<https://support.industry.siemens.com/cs/ww/en/ps/3SE5000-0AA50>

Image database (product images, 2D dimension drawings, 3D models, device circuit diagrams, EPLAN macros, ...)

http://www.automation.siemens.com/bilddb/cax_de.aspx?mlfb=3SE5000-0AA50&lang=en

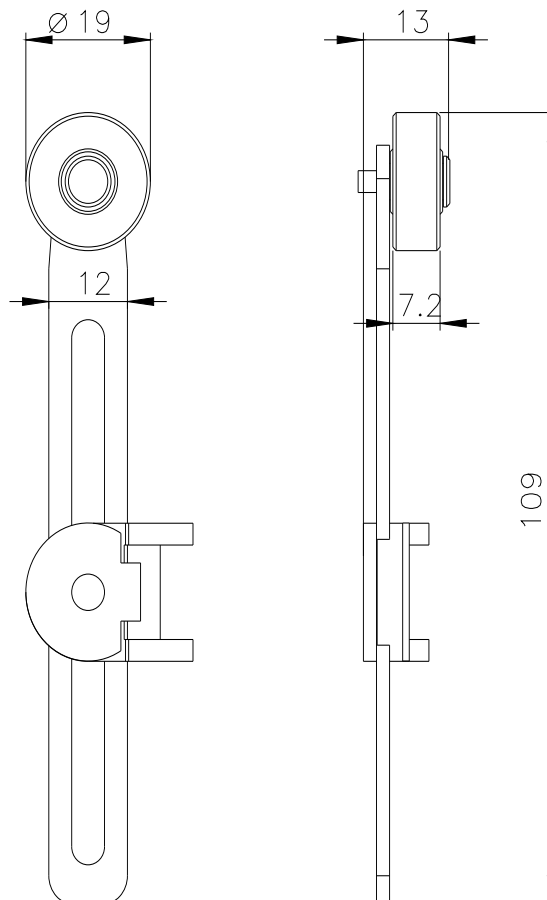

last modified:

12/21/2020

