



TeSys D Green

Catalogue 2017
AC/DC compatible coil contactors



schneider-electric.com

Life Is On | **Schneider**
Electric



Green Premium™

Endorsing eco-friendly products in the industry



Green Premium™ Product

Green Premium is the only label that allows you to effectively develop and promote an environmental policy whilst preserving your business efficiency. This ecolabel guarantees compliance with up-to-date environmental regulations, but it does more than this.

Over 75% of Schneider Electric manufactured products have been awarded the Green Premium ecolabel



Discover what we mean by green

Check your products!

Schneider Electric's Green Premium ecolabel is committed to offering transparency, by disclosing extensive and reliable information related to the environmental impact of its products:

RoHS

Schneider Electric products are subject to RoHS requirements at a worldwide level, even for the many products that are not required to comply with the terms of the regulation. Compliance certificates are available for products that fulfil the criteria of this European initiative, which aims to eliminate hazardous substances.

REACH

Schneider Electric applies the strict REACH regulation on its products at a worldwide level, and discloses extensive information concerning the presence of SVHC (Substances of Very High Concern) in all of these products.

PEP: Product Environmental Profile

Schneider Electric publishes complete set of environmental data, including carbon footprint and energy consumption data for each of the lifecycle phases on all of its products, in compliance with the ISO 14025 PEP ecopassport program. PEP is especially useful for monitoring, controlling, saving energy, and/or reducing carbon emissions.

EoLI: End of Life Instructions

Available at the click of a button, these instructions provide:

- Recyclability rates for Schneider Electric products.
- Guidance to mitigate personnel hazards during the dismantling of products and before recycling operations.
- Parts identification for recycling or for selective treatment, to mitigate environmental hazards/ incompatibility with standard recycling processes.

Contents

New TeSys D Green contactors series with AC/DC coils



TeSys D Green contactors	
	Page
Discovery	4
Contactors references	6
Auxiliaries, accessories references	10
Motor starters mounting and wiring systems	17
Coordinated starters selection tables 23	
Technical Data for Designers 31	

TeSys D legacy contactors 9 to 150 A, for motor control and other applications.



9, 12, 18 A



25, 32, 38 A



40, 50, 65 A



80, 95 A



115, 150 A



Discover TeSys D and other contactor ranges in the TeSys global catalogue.

TeSys D Green contactors

TeSys D range now enriched with new contactors, featuring AC/DC coils (every coil can be energized with either AC or DC), lower consumption and even more.

Check for 5 major advantages

1

Low control current > **Lower permanent consumption**

Reduced coil power (just 0.5 W / 24 V DC for the BBE coil) contributing to increase machine energy efficiency.

2

Low control current > **Direct PLC control for contactors up to 80 A ⁽¹⁾**

TeSys D Green contactors (with BBE coil code) can be driven by a common 24 V DC / 500 mA static output, a relay interface is no longer needed.

3

Coil current permanent monitoring / control > **Constant closing / opening time** regardless of voltage fluctuation, for reliable repetitive actions.

4

Coil current permanent monitoring / control > **Reduced contacts bounces** due to machine shocks and vibrations, preventing from microbreaks.

5

Keeps legacy standard dimensions and terminal assignment > **one 'TeSys D Green' can replace many 'TeSys D' contactors as a spare**, when maintenance is needed, with better performances.

(1) 80 A rating available end 2017.



Only 4 contactors in each rating, for covering control voltages from 24 to 500 V DC or AC.

> Significant stock reduction.

TeSys D Green contactors

Coil currents comparison

TeSys D Green (AC/DC coil) vs Tesys D legacy (AC, DC coils)

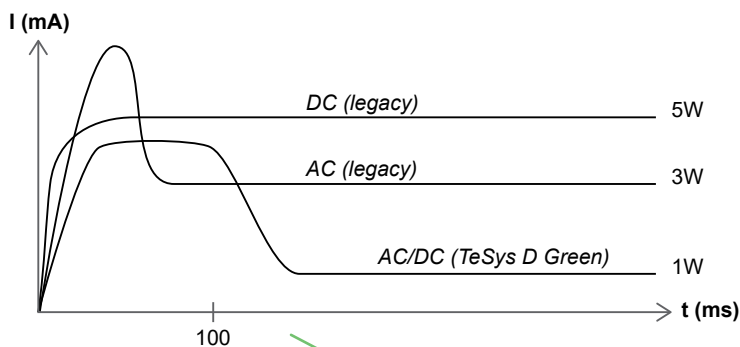

TeSys D Green brings a significant reduction of energy consumption.

TeSys D Green (AC/DC "BBE" coil) vs TeSys D (low consumption "BL" coil)

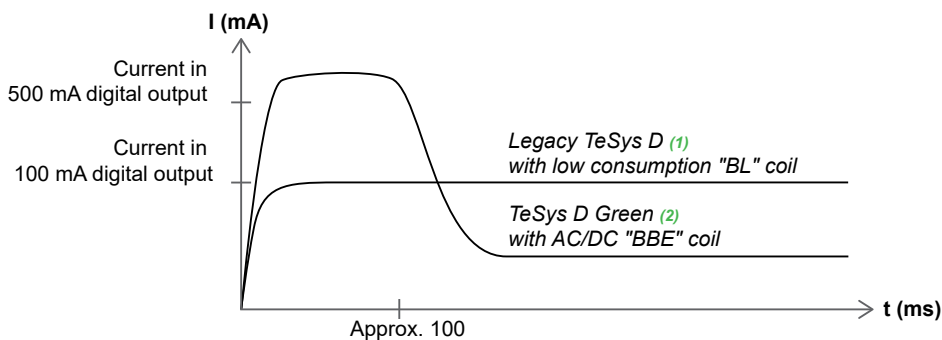

(1) Up to 38 A.
(2) 45 to 80 A.

TeSys D Green is well adapted to direct control by PLC static outputs, even in its high ratings.

TeSys D Green - exploded view

TeSys D Green contactors keep the same high resistance to shock and vibration as TeSys D, their coils offer a wider control voltage band and a lower permanent consumption.

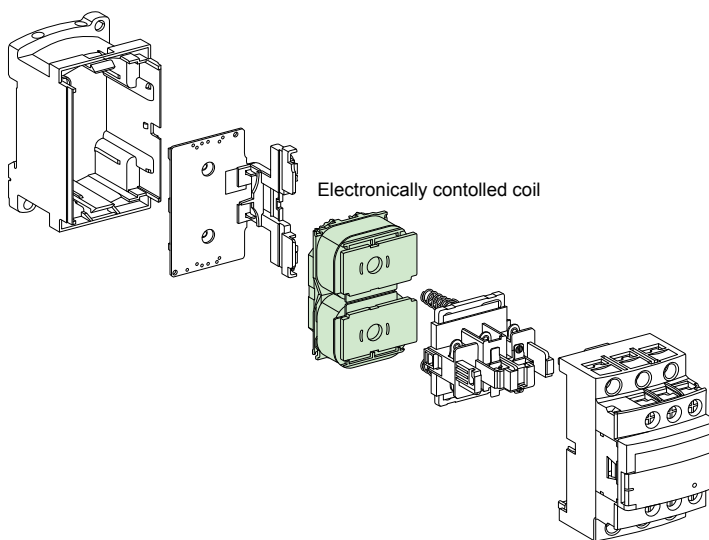

TeSys D Green contactors

For motor control up to 37 kW / 400 V Category AC-3



LC1 D09●●●



LC1 D40A●●●

3-pole contactors										
Standard power ratings of 3-phase motors 50-60 Hz in category AC-3 (θ ≤ 60 °C)						Rated operational current in AC-3 440 V up to	Instan- taneous auxiliary contacts	Basic reference, to be completed by adding the control voltage code		Weight
220 V 230 V	380 V 400 V	415 V	440 V	500 V	660 V 690 V			Fixing ⁽¹⁾		
kW	kW	kW	kW	kW	kW	A				kg
Connection by screw clamp terminals										
2.2	4	4	4	5.5	5.5	9	1	1	LC1D09●●●	0.368
3	5.5	5.5	5.5	7.5	7.5	12	1	1	LC1D12●●●	0.373
4	7.5	9	9	10	10	18	1	1	LC1D18●●●	0.378
5.5	11	11	11	15	15	25	1	1	LC1D25●●●	0.433
7.5	15	15	15	18.5	18.5	32	1	1	LC1D32●●●	0.438
9	18.5	18.5	18.5	18.5	18.5	38	1	1	LC1D38●●●	0.442
Power connections by EverLink® BTR ⁽²⁾ screw connectors and control by screw clamp terminal										
11	18.5	22	22	22	30	40	1	1	LC1D40A●●●	0.992
15	22	25	30	30	33	50	1	1	LC1D50A●●●	0.997
18.5	30	37	37	37	37	65	1	1	LC1D65A●●●	1.002
22	37	37	37	45	45	80	1	1	LC1D80A●●● ⁽³⁾	1.002

Auxiliary contact blocks and add-on modules

See pages 10 to 14.

Control voltage codes

AC/DC supply					
Volts	24 (DC only)	24-60	48-130	100-250	250 V - 415 V AC / 250 V - 500 V DC

LC1D09 ...D38, LC1D40A ... D80A					
U 0.85...1.1 Uc		BNE	EHE	KUE	USE ⁽³⁾
LC1D40A ... D80A					
U 0.8...1.2 Uc	BBE				

(1) LC1 D09 to D80A: clip-on mounting on 35 mm U rail AM1 DP or screw fixing.
 (2) BTR screws: hexagon socket head. In accordance with local electrical wiring regulations, a size 4 insulated Allen key must be used (reference LAD ALLEN4, see page 14).
 (3) Available end of 2017.

References

TeSys D Green reversing contactors

For motor control up to 37 kW / 400 V Category AC-3

DB424874 eps



LC2 D09●●●

DB424870 eps



LC2 D40A●●●

3-pole reversing contactors

Pre-wired power connections

Standard power ratings of 3-phase motors 50-60 Hz in category AC-3 ($\theta \leq 60^\circ\text{C}$)						Rated operational current in AC-3 440 V up to	Instantaneous auxiliary contacts per contactor	Contactors supplied with coil Partial reference, to be completed by adding the control voltage code	Weight
220 V	380 V	415 V	440 V	500 V	660 V 230 V 400 V				
kW	kW	kW	kW	kW	kW	A			kg

With mechanical interlock, without electrical interlocking, for connection by screw clamp terminals or Everlink BTR screw connectors ^{(2) (3)}

2.2	4	4	4	5.5	5.5	9	1	1	LC2D09●●●	0.783
3	5.5	5.5	5.5	7.5	7.5	12	1	1	LC2D12●●●	0.793
4	7.5	9	9	10	10	18	1	1	LC2D18●●●	0.803
5.5	11	11	11	15	15	25	1	1	LC2D25●●●	0.913
7.5	15	15	15	18.5	18.5	32	1	1	LC2D32●●●	0.923
9	18.5	18.5	18.5	18.5	18.5	38	1	1	LC2D38●●●	0.933
11	18.5	22	22	22	30	40	1	1	LC2D40A●●● ⁽²⁾	2.154
15	22	25	30	30	33	50	1	1	LC2D50A●●● ⁽²⁾	2.164
18.5	30	37	37	37	37	65	1	1	LC2D65A●●● ⁽²⁾	2.174
22	37	37	37	45	45	80	1	1	LC2D80A●●● ^{(2) (4)}	2.174

Auxiliary contact blocks and add-on modules

See pages 10 to 15.

Coil voltage codes

AC/DC supply

Volts	24 (DC only)	24-60	48-130	100-250	250 V - 415 V AC / 250 V - 500 V DC
LC2D09 ...D32, LC2D40A ... D80A					
U 0.85...1.1 Uc		BNE	EHE	KUE	USE ⁽⁴⁾
LC2 D40A ...D80A					
U 0.8...1.2 Uc	BBE				

⁽¹⁾ LC2 D09 to D80A: clip-on mounting on 35 mm rail AM1 DP or screw fixing.

⁽²⁾ BTR screws: hexagon socket head. In accordance with local electrical wiring regulations, a size 4 insulated Allen key must be used (reference LAD ALLEN4, see page 14).

⁽³⁾ Electrical interlocking is recommended when 2 orders (direct and reverse) could appeared in the same time.

⁽⁴⁾ Available end of 2017.

References

TeSys D Green contactors

For load control from 25 to 80 A Category AC-1



LC1 D09●●●



LC1 D40A●●●



LC1 DT60A●●●

3-pole contactors					
Non inductive loads maximum current ($0 \leq 60^\circ\text{C}$) utilisation category AC-1	Number of poles	Instantaneous auxiliary contacts		Partial reference, to be completed by adding the control voltage code	Weight
				Fixing ⁽¹⁾	
A					kg
Connection by screw clamp terminals					
25	3	1	1	LC1D09●●●	0.368
				or LC1D12●●●	0.373
32	3	1	1	LC1D18●●●	0.378
40	3	1	1	LC1D25●●●	0.433
50	3	1	1	LC1D32●●●	0.438
				or LC1D38●●●	0.442
Connection by EverLink®, BTR screw connectors ⁽²⁾					
60	3	1	1	LC1D40A●●●	0.992
80	3	1	1	LC1D50A●●●	0.997
				or LC1D65A●●● ⁽³⁾	1.002
4-pole contactors ⁽⁴⁾					
Connection by EverLink®, BTR ⁽²⁾ screw connectors					
60	4	1	1	LC1DT60A●●●	1.230
80	4	1	1	LC1DT80A●●● ⁽⁴⁾	1.290
4-pole changeover contactors ⁽⁴⁾					
Connection by EverLink®, BTR ⁽²⁾ screw connectors					
60	4	1	1	LC2DT60A●●●	2.460
80	4	1	1	LC2DT80A●●● ⁽⁴⁾	2.580
Control voltage codes					
AC/DC supply					
Volts	24 (DC only)	24-60	48-130	100-250	250 V - 415 V AC / 250 V - 500 V DC
LC1 D09...D65A and LC●DT60A...DT80A					
U 0.85 1.1 Uc		BNE	EHE	KUE	USE ⁽⁵⁾
LC1D40 to LC1D65A, LC●DT60A to LC●DT80A					
U 0.8...1.2 Uc		BBE			

⁽¹⁾ LC1 D09 to D65A, LC●DT60A and LC●DT80A: clip-on mounting on 35 mm \square rail AM1 DP or screw fixing.
⁽²⁾ BTR screws: hexagon socket head. In accordance with local electrical wiring regulations, a size 4 insulated Allen key must be used (reference LAD ALLEN4, see page 14).
⁽³⁾ Selection according to the number of operating cycles, see AC-1 curve, page 36.
⁽⁴⁾ Available in 2018.
⁽⁵⁾ Available end of 2017.

References

TeSys D Green contactors

For North American market, conforming to UL ⁽¹⁾ and CSA standards 25 to 80 A



LC1 D09●●●



LC1 D40A●●●

Contactors							Associated cable type 75 °C-Cu	Continuous current	Type of contactor required Partial reference, to be completed by adding the control voltage code Fixing, connection ⁽²⁾
Standard power ratings of motors 50/60 Hz									
Single-phase 1 Ø		3-phase 3 Ø							
115 V	230 V	200 V	230 V	460 V	575 V				
	240 V	208 V	240 V	480 V	600 V				
HP	HP	HP	HP	HP	HP	A			
Connection by screw clamp terminals									
1/3	1	2	2	5	7.5	AWG 18 - 10	25	LC1D09●●●	
0.5	2	3	3	7.5	10	AWG 18 - 10	25	LC1D12●●●	
1	3	5	5	10	15	AWG 18 - 8	32	LC1D18●●●	
2	3	7.5	7.5	15	20	AWG 14 - 6	40	LC1D25●●●	
2	5	10	10	20	25	AWG 14 - 6	50	LC1D32●●●	
Power connections by EverLink® BTR ⁽³⁾ screw connectors and control by spring terminals									
3	5	10	10	30	30	AWG 16 - 2	60	LC1D40A●●●	
3	7.5	15	15	40	40	AWG 16 - 2	70	LC1D50A●●●	
5	10	20	20	40	50	AWG 16 - 2	80	LC1D65A●●●	

Applications with High-Fault Short-Circuit ratings

For contactors LC1 D40A to LC1 D65A, the High-Fault Short-Circuit ratings are: 100 kA at 600 V with class J fuses and 85 kA (D09-38), 100 kA (D40A-65A) at 480 V and 50 kA at 600 V with circuit breakers.

Control voltage codes

AC/DC supply					
Volts	24 (DC only)	24-60	48-130	100-250	250 V - 415 V AC / 250 V - 500 V DC
LC1D09 ... D32, LC1D40A ... D65A					
U 0.85 1.1 Uc		BNE	EHE	KUE	USE ⁽⁴⁾
LC1D40A ... D65A					
U 0.8...1.2 Uc		BBE			

⁽¹⁾ Certification in progress

⁽²⁾ LC1 D09 to D65: clip-on mounting on 35 mm \perp rail AM1 DP or screw fixing.

⁽³⁾ BTR screws: hexagon socket head. In accordance with local electrical wiring regulations, a size 4 insulated Allen key must be used (reference LAD ALLEN4, see page 14).

⁽⁴⁾ Available end of 2017.

TeSys contactors

TeSys D contactors and reversing contactors

Instantaneous auxiliary contact blocks

DG423133R-eps

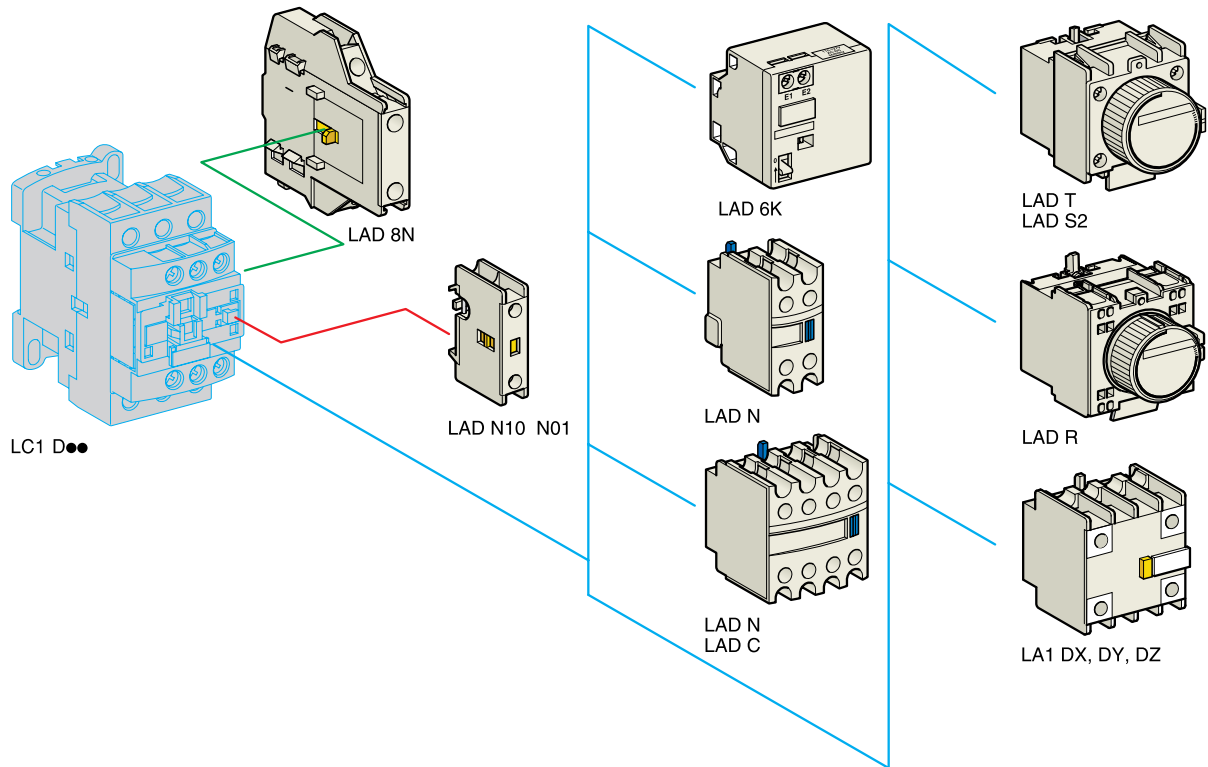

Instantaneous auxiliary contact blocks for connection by screw clamp terminals

For use in normal operating environments

Clip-on mounting	Number of contacts per block ⁽¹⁾	Composition					Reference
Front	1	-	-	-	1	-	LADN10
		-	-	-	-	1	LADN01
	2	-	-	-	1	1	LADN11
		-	-	-	2	-	LADN20
		-	-	-	-	2	LADN02
	4	-	-	-	2	2	LADN22 LADN22S ⁽¹⁾
		-	-	-	1	3	LADN13
		-	-	-	4	-	LADN40
		-	-	-	-	4	LADN04
		-	-	-	3	1	LADN31
	4 incl. 1 N/O & 1 N/C make before break	-	-	-	2	2	LADC22
Side	2	-	-	-	1	1	LAD8N11
		-	-	-	2	-	LAD8N20
		-	-	-	-	2	LAD8N02

For terminal referencing conforming to EN 50012

Front on 3P contactors and	2	-	-	-	1	1	LADN11G
4P contactors 20 to 80 A	4	-	-	-	2	2	LADN22G

With dust and damp protected contacts, for use in particularly harsh industrial environments

Front	2	-	2	-	-	-	LA1DX20
		1	1	-	-	-	LA1DX11
	4	2	-	-	-	-	LA1DX02
		-	2	2	-	-	LA1DY20 ⁽²⁾
		-	2	-	2	-	LA1DZ40
	-	2	-	1	1	LA1DZ31	

Maximum number of auxiliary contacts per rating

Contactors			Instantaneous auxiliary contacts				Time delay
Coil	Pole	Rating ref.	Side mounted	Front mounted			Front mounted
				1 contact	2 contact	4 contact	
AC/DC compatible	3P	LC1 D09...D38	1 on Right Hand side	and -	1	-	or 1
		LC1 D40A...D80A	1 on RH or LH side	and -	1	-	or 1
	4P	LC1 DT60A and DT80A	1 on RH or LH side	and -	1	-	or 1

⁽¹⁾ With red front face - for safety chain indication.

⁽²⁾ Device fitted with 4 earth screen continuity terminals.

References

TeSys contactors

TeSys D contactors and reversing contactors

Time delay auxiliary contact blocks, mechanical latch blocks

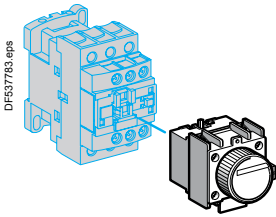

LAD T●

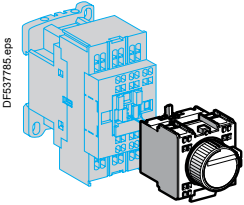

LAD R●

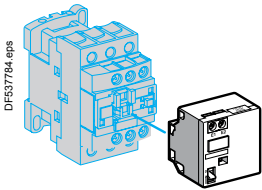

LAD 6K10●

Time delay auxiliary contact blocks for connection by screw clamp terminals

Maximum number of auxiliary contact blocks that can be fitted per contactor, see page 10.

Sealing cover to be ordered separately, see page 14.

LAD T0 and LAD R0: with extended scale from 0.1 to 0.6 s.

LAD S2: with switching time of 40 ms ± 15 ms between opening of the N/C contact and closing of the N/O contact.

Clip-on mounting	Number of contacts	Time delay		Reference
		Type	Setting range	
Front	1 N/O + 1 N/C	On-delay	0.1...3 s	LADT0
			0.1...30 s	LADT2
			10...180 s	LADT4
		Off-delay	1...30 s	LADS2
			0.1...3 s	LADR0
			0.1...30 s	LADR2
		10...180 s	LADR4	

Mechanical latch blocks ⁽¹⁾

Clip-on mounting	Unlatching control	For use on contactor		Partial reference to be completed with coil voltage code ⁽²⁾
		Pole	Coil (3)	
Front	Manual or electric	3	AC or DC or AC/DC	LC1D09 ... D38 LC1D40A ... D80A
		4	AC or DC or AC/DC	LC1DT20... DT40 LC1DT60A... DT80A

Coil voltage codes

Volts	50/60 Hz	24	32/36	42/48	60/72	100	110/127	220/240	256/277	380/415	
Code			B	C	E	EN	K	F	M	U	Q

⁽¹⁾ The mechanical latch block must not be powered up at the same time as the contactor.

The duration of the control signal for the mechanical latch block and the contactor should be:

≥ 100 ms for a contactor with AC coil,

≥ 250 ms for a contactor with DC or AC/DC coil.

Maximum impulse duration for the LAD 6K10● mechanical latch block: 10 seconds.

⁽²⁾ Standard control circuit voltages (for other voltages, please consult your Regional Sales Office):

⁽³⁾ The DC, low consumption contactors (coil code ●L) are not compatible with the mechanical latch blocks LAD6K10●.

TeSys contactors

TeSys D contactors and reversing contactors

Accessories

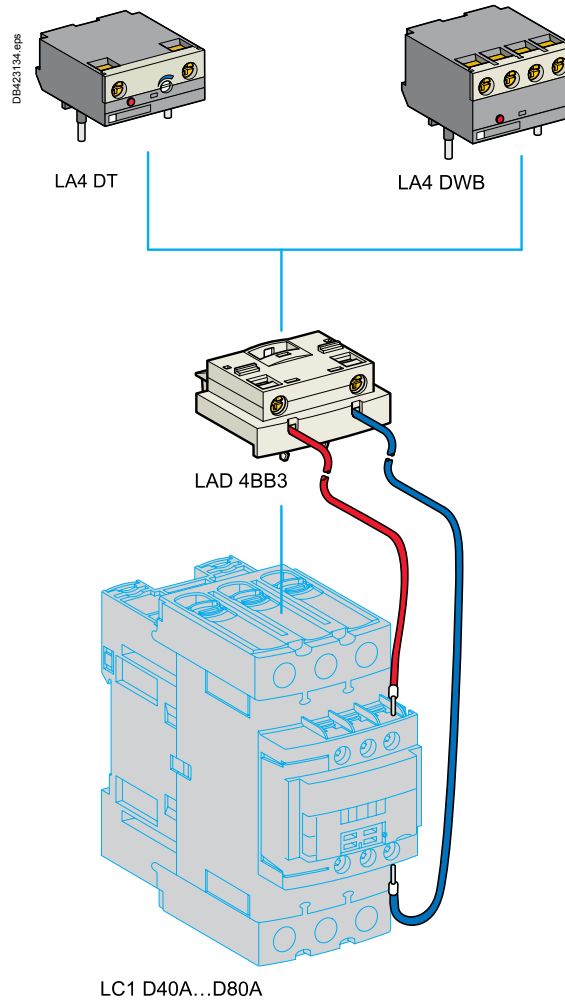

Electronic serial timer modules ⁽¹⁾

■ To be mounted on 3P contactors LC1D40A to D80A using LAD4BB3 wiring adapter (to be ordered separately).

On-delay type		
Operational voltage ~	Time delay	Reference
24...250 V		
LC1D40A ... LC1D80A	0.1...2 s	LA4DT0U
	1.5...30 s	LA4DT2U
	25...500 s	LA4DT4U

Static relay interface module

■ To be mounted on 3P contactors LC1D40A to D80A using LAD4BB3 wiring adapter (to be ordered separately).

Relay interface with "AUTO-I" manual override switch (output forced "ON"), solid state type		
Operational voltage ~	Supply voltage E1-E2 (---)	Reference
24...250 V		
LC1 D40A...D80A	24 V	LA4DWB

Wiring adapter

■ For use with LADT●● timer module, LAD4DWB static relay interface module or for adapting existing top terminals wiring (old contactor) to front terminals (new 3P contactor).

Module with extension cables		
For use on contactors		Reference
LC1 D40A...D80A	Without coil suppression	LAD4BB3

⁽¹⁾ The contactor must be fitted with a BNE, or BBE coil.

TeSys contactors

TeSys D contactors and reversing contactors

Accessories

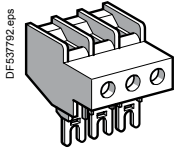

LA9 D3260

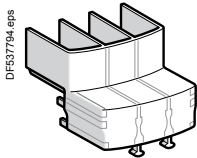

LAD 96570

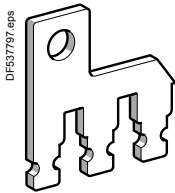

LAD9P3

Accessories for main pole and control connections

Description		For use with contactors LC1		Sold in lots of	Unit reference
		AC / DC			
Connectors for cable, size (1 connector)	3-pole 25 mm ²	D09...D38		1	LA9D3260
EverLink® terminal block	3-pole	D40A...D80A		1	LAD96560
Protective covers for connectors for lug type terminals	3-pole	D40A6...D80A		1	LAD96570
IP 20 covers for lug type terminals (for mounting with circuit breakers GV3 P●●6 and GV3 L●●6)	3 poles	D40A6...D80A		1	LAD96575
Links for parallel connection of	2 poles	D09...D38	D09...D38	10	LA9D2561
		D40A...D80A		1	LAD9P32
	3 poles	D09...D38	D09...D38	10	LAD9P3 ⁽¹⁾
		D40A...D80A		1	LAD9P33

TeSys contactors

TeSys D contactors and reversing contactors

Accessories

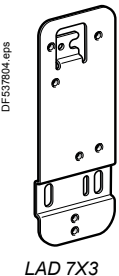
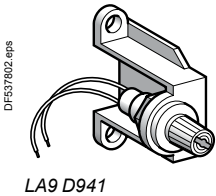
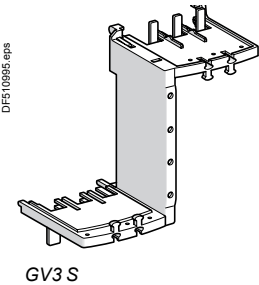
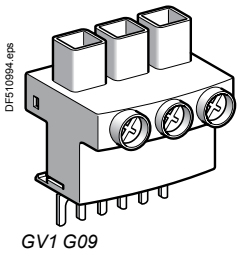
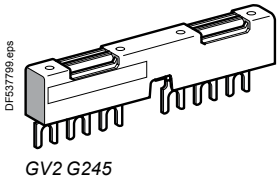

Power connection accessories

Terminal block	For supply to one or more GV2 G busbar sets	GV1G09
Set of 63 A busbars for parallelling of contactors	2 contactors LC1 D09...D18 or D25...D38	GV2G245
	4 contactors LC1 D09...D18 or D25...D38	GV2G445
Set of 115 A busbars for parallelling of contactors	2 contactors LC1 D40A...D80A	GV3G264
	3 contactors LC1 D40A...D80A	GV3G364 ⁽¹⁾
Set of S-shape busbars	For circuit breakers GV3 P●● and GV3 L●● and contactors LC1 D40A...D65A	GV3S

Protection accessories

Description	Use	Sold in lots of	Reference
Miniature control circuit fuse holder	5 x 20 with 4 A-250 V fuse	1	LA9D941
Sealing cover	For LAD T, LAD R	1	LA9D901
Safety cover preventing access to the moving contact carrier	LC1 D09...D80A Red cover (for safety chain indication)	1	LAD9ET1 LAD9ET1S

Marking accessories

Description	Use	Sold in lots of	Unit reference
Sheet of 64 blank legends, self-adhesive, 8 x 33 mm ⁽²⁾	Contactors (except 4P) LAD N (4 contacts), LA6 DK	10	LAD21
Sheet of 112 blank legends, self-adhesive, 8 x 12 mm ⁽²⁾	LAD N (2 contacts), LAD T, LAD R, LRD	10	LAD22
Sheet of 440 blank legends for marking using plotter or 8 x 12 mm engraver	All products	35	LAD24
Marker holder snap-in, 8 x 18 mm	LC1 D09...D80A, LC1 DT60...DT80A, LAD N (4 contacts), LAD T, LAD R	100	LAD90
Bag of 300 blank legends self-adhesive, 7 x 21 mm	On holder LA9 D92	1	LA9D93
"SIS Label" labelling software supplied on CD-Rom	Multi-language version: English, French, German, Italian, Spanish	1	XBY2U

Mounting accessories

Retrofit plate for screw fixing	For replacement of LC1 D40 to D65 by LC1 D40A to D80A	1	LAD7X3
Size 4 Allen key, insulated, 1000 V	For use on contactors LC1 D40A to LC1 D150	5	LADALLEN4

⁽¹⁾ With this set of busbars, any one contactor can be supplied directly by its EverLink® double cage power terminal block. The other two contactors are supplied by the busbar set. The 115 A limitation is therefore applied to these two contactors. Example: 1 LC1 D65A supplied directly + 1 contactor LC1 D65A and 1 contactor LC1 D50 A supplied via the busbar set = 115 A. This combination is compatible with busbar set GV3 G364.

⁽²⁾ These legends are for sticking onto the safety cover of the contactors or add-on block, if fitted.

TeSys contactors

Component parts for assembling reversing or changeover contactors pairs

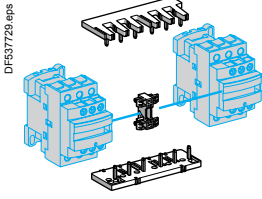

LAD 9R1

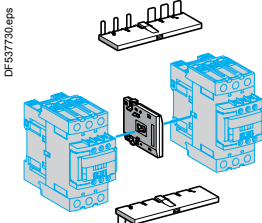

LAD 9R3



LA9 D8070

For 3-pole reversing contactors for motor control

Contactors with screw clamp terminals or connectors. Horizontally mounted, assembled by customer.

Description	For contactors ⁽¹⁾ (2 identical contactors)	Reference
Kits for assembly of reversing contactors		
Kit comprising: ■ a mechanical interlock LAD 9V2 with electrical interlocking LAD 9V1 ■ a set of power connections LAD 9V5 (parallel) and LAD 9V6 (reversing).	LC1 D09 to D38	LAD9R1V
Kit comprising: ■ a mechanical interlock LAD 9V2 without electrical interlocking ■ a set of power connections LAD 9V5 (parallel) and LAD 9V6 (reversing).	LC1 D09 to D38	LAD9R1
Kit comprising: ■ a mechanical interlock LAD 4CM ■ a set of power connections LA9 D65A69 .	LC1 D40A to D80A	LAD9R3
Mechanical interlocks		
Mechanical interlock without integral electrical interlocking	LC1 D09 to D38	LAD9V2
	LC1 D40A to D80A	LAD4CM
Sets of power connections		
Comprising: ■ a set of parallel bars ■ a set of reverser bars.	LC1 D09 to D38 with screw clamp terminals or connectors	LAD9V5 + LAD9V6
	LC1 D09...D32 with spring terminal connections	LAD9V12 + LAD9V13 ⁽²⁾
	LC1 D40A to D80A	LA9D65A69

For star-delta starter

Description	For contactors	Reference
Mounting kit comprising: ■ 1 time delay contact block LAD S2 (LC1 D09...D80), ■ power circuit connections (LC1 D09...D80), ■ hardware required for fixing the contactors onto the mounting plate (LC1 D80).	LC1 D09 and D12	LAD91217
	LC1 D18 to D32	LAD93217
	LC1 D40A and D50A	LAD9SD3
	LC1 D80A	LA9D8017
Equipment mounting plates	LC1 D09, D12 and D18	LA9D12974
	LC1 D32	LA9D32974
	LC1 D40A and D50A	–
	LC1 D80A	LA9D80973

For 3-pole changeover contactor pairs

Contactors with screw clamp terminals or connectors. Horizontally mounted, assembled by customer.

Description	For contactors ⁽¹⁾ (2 identical contactors)	Reference
Mechanical interlocks		
Without integral electrical interlocking	LC1 D40A...D80A	LAD9R3S

⁽¹⁾ To order the 2 contactors: see page 7.

⁽²⁾ To assemble a reversing contactor with spring terminal connections, the following components must be ordered:

- 1 mechanical interlock **LAD 9V2**,

- 1 upstream power connection kit and 1 downstream power connection kit.

Upstream power connection kit **LAD 9V10**: installed in the Quickfit system with power connection module **LAD 34**.

(If module **LAD 34** is not used, replace **LAD 9V10** with **LAD 9V12**).

Downstream power connection kit **LAD 9V11**: installed in the Quickfit system with outgoing terminal block **LAD 331**.

(If **LAD 331** is not used, replace **LAD 9V11** with **LAD 9V13**).

TeSys contactors

TeSys D Green

Coordination with PLC DC and relay output modules

Selection of PLC coordinated contactors

Laboratory tests have been carried out in order to certify trouble free contactor closings and openings with different PLC output modules.

The coil must be defined according to the contactor rating range and output module. See selection table below.

The PLC your are using				>>>	Compatible contactors ⁽¹⁾	Coil code
PLC type	Output type	Output I (A)	Output module commercial reference			
M221 / M241 / M251	Static output: 24 V DC	0.5	TM3DQ8●●● and Q16●●● (T, TG, U, UG)	>>>	LC1D09●● to LC1D38●●, LC1D40A●●● to LC1D80A, LC1DT60A●●● to LC1DT80A●●●	BL, BBE
		0.3 (sealed) 0.8 (inrush)	TM3XTYS4	>>>	LC1D40A●●● to LC1D80A, LC1DT60A●●● to LC1DT80A●●●	BBE, BL, BD, BNE
		0.1	TM3DQ16●● and Q32●● (TK, UK)	>>>	LC1D09●● to LC1D38●●	BL
	Relay output: 24 V DC / 230 V AC	2	TM3DQ8 and DQ16 (R, RG), TM3DM8 and DM24 (R, RG)	>>>	LC1D09●● to LC1D38●●, LC1D40A●●● to LC1D80A, LC1DT60A●●● to LC1DT80A●●●	Code of any DC coil up to 24 V or any AC coil up to 230 V
M340 / M580	Static output: 24 V DC	0.5	BMXDDO1602 and DM16022	>>>	LC1D09●● to LC1D38●●, LC1D40A●●● to LC1D80A, LC1DT60A●●● to LC1DT80A●●●	BL, BBE
		0.1	BMXDDO3202, BMXDDM3202K, BMXDDO6402K	>>>	LC1D09●● to LC1D38●●	BL
	Relay output: 24 V DC / 230 V AC	2	BMXDRA0805 and DM16025	>>>	LC1D09●● to LC1D38●●, LC1D40A●●● to LC1D80A, LC1DT60A●●● to LC1DT80A●●●	Code of any DC coil up to 24 V or any AC coil up to 230 V
	Triac output: 230 V AC	0.6	BMXDAO1605	>>>	LC1D09●● to LC1D38●●, LC1D40●●● to LC1D80A●●●, LC1DT60A●●● to LC1DT80A●●●	Code of any AC coil up to 230 V (P7 code = 230 V)
AVANTYS	Static output: 24 V DC	0.5	STBDDO3200	>>>	LC1D09●● to LC1D38●●, LC1D40A●●● to LC1D80A, LC1DT60A●●● to LC1DT80A●●●	BL, BBE
	Triac output: 230 V AC	2	STBDAO8210	>>>	LC1D09●● to LC1D38●●, LC1D40A●●● to LC1D80A, LC1DT60A●●● to LC1DT80A●●●	Code of any AC coil up to 230 V (P7 code = 230 V AC)

Coils consumption characteristics

Coil type	Uc DC - min -max	Average consumption at UC DC / 20 °C	
		Inrush	Sealed
BL	24 V - 0.8 Uc to 1.1 Uc	2.4 VA	2.4 W - 2.4 VA
BBE		11 W - 12.5 VA	0.5 W - 0.5 VA

(1) Replace dot by coil code. Ex LC1D09●● becomes LC1D09BL.

Motor starters mounting and wiring systems using TeSys D contactors and TeSys GV circuit breakers

Motor starters mounting and wiring systems		Page
Linergy BZ Snap-on mounting plates, busbar chassis		18
Linergy HK Hot-plug, snap-on mounting plates, pluggable busbar		19
TeSys GV Adapter plates, comb busbars		20
TeSys SoLink Prefabricated monitoring/control wiring modules for motor starters		21

Lineryy BZ

Snap-on mounting plates, busbar chassis

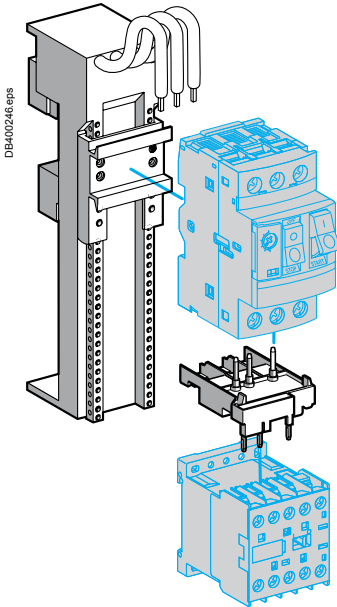

LA9ZA32621 mounting plate,
GV2AF01 combination block

Motor starters applications

Lineryy BZ is intended for compact, modular, motor starters composition: Direct-On-Line or reversing.

Every starter is composed of:

- 1 snap-on mounting plate + 1 GV2 or GV3 circuit breaker
- 1 snap-on mounting plate + 1 GV2 or GV3 circuit breaker + 1 moulded connector + 1 LC1D contactor

Or

- 1 snap-on mounting plate + 1 TeSys U all-in-one starter.

Mounting plates:

- 25, 32 or 63 A
- single, double width (45, 90 mm)
- DIN rail fixing bracket for c. b. + contactor assemblies.

Electrical power distribution applications

Lineryy BZ provides power supply to the directly connected starters and branch circuits.

The busbar system is composed of mounting brackets, copper bars (not provided by Schneider Electric), terminals, connection modules, insulating covers.

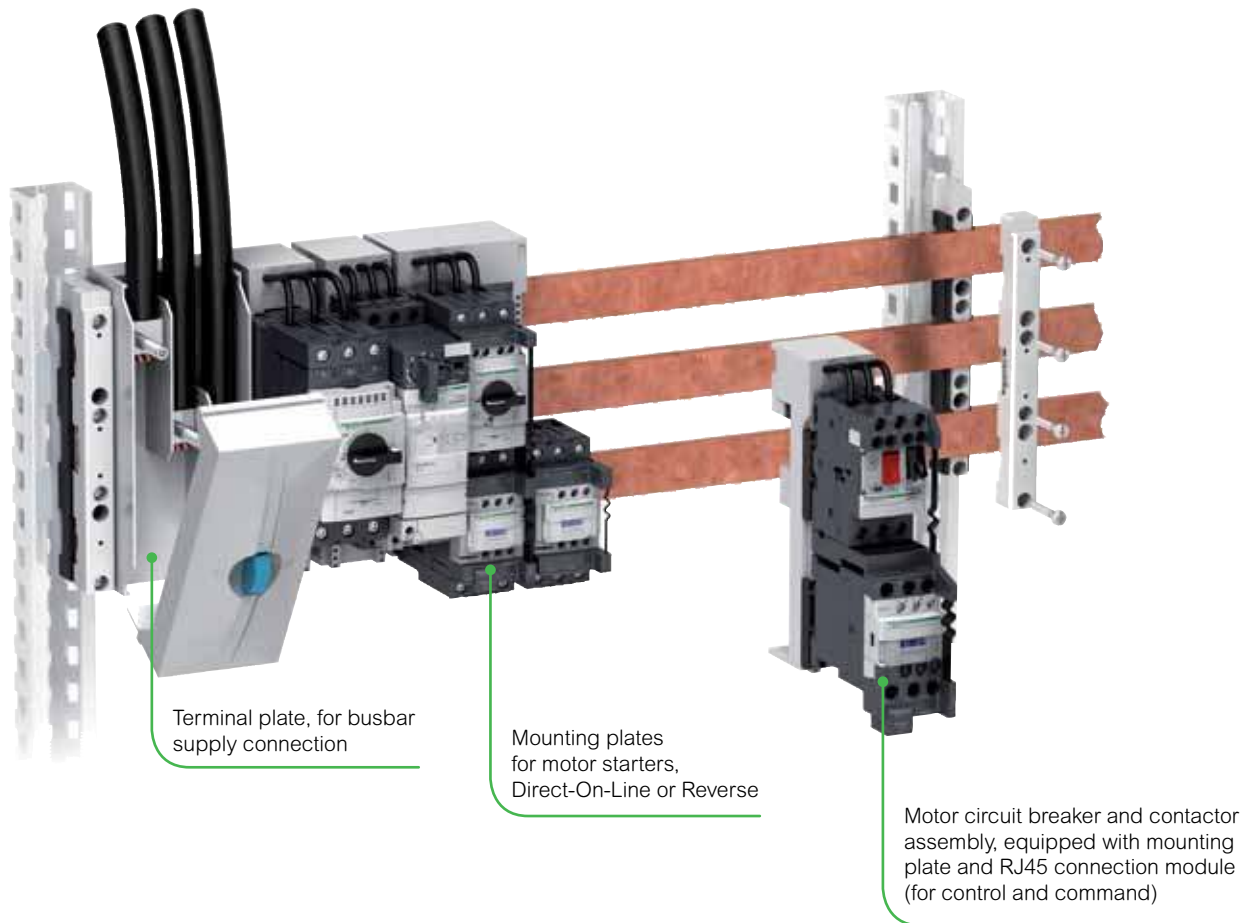

Terminal plate, for busbar supply connection

Mounting plates for motor starters, Direct-On-Line or Reverse

Motor circuit breaker and contactor assembly, equipped with mounting plate and RJ45 connection module (for control and command)

> For more details, download: TeSys – Motor control and protection components catalogue - chapter B1 Catalogue ref MKTED210011EN

Click [HERE](#) for immediate download of Lineryy Chapter.

Linergy HK

Hot-plug, snap-on mounting plates, pluggable busbar

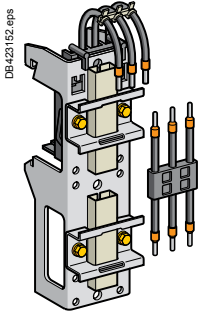

AK5PA232

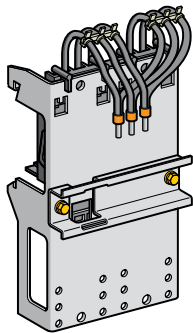

AK5PA532

Motor starters applications

Linergy HK is intended for compact, modular, motor starters composition: Direct-On-Line or reversing.

Every starter is composed of:

- 1 pluggable mounting plate + 1 modular or GV2 or GV3 circuit breaker
- 1 pluggable mounting plate + 1 GV2 or GV3 circuit breaker + 1 connector + 1 LC1D contactor

Or

- 1 pluggable mounting plate + 1 TeSys U all-in-one starter.

Mounting plates:

- 25 or 50 A
- single, double width (54, 108 mm)
- DIN rail fixing bracket for c. b. + contactor assemblies.

Electrical power distribution applications

Linergy HK provides power supply to the directly connected starters and branch circuits, with hot-plug possibilities for easier maintenance.

The busbar system is composed of omega rails, pluggable busbars with embedded supply terminal block, power sockets, connection modules.

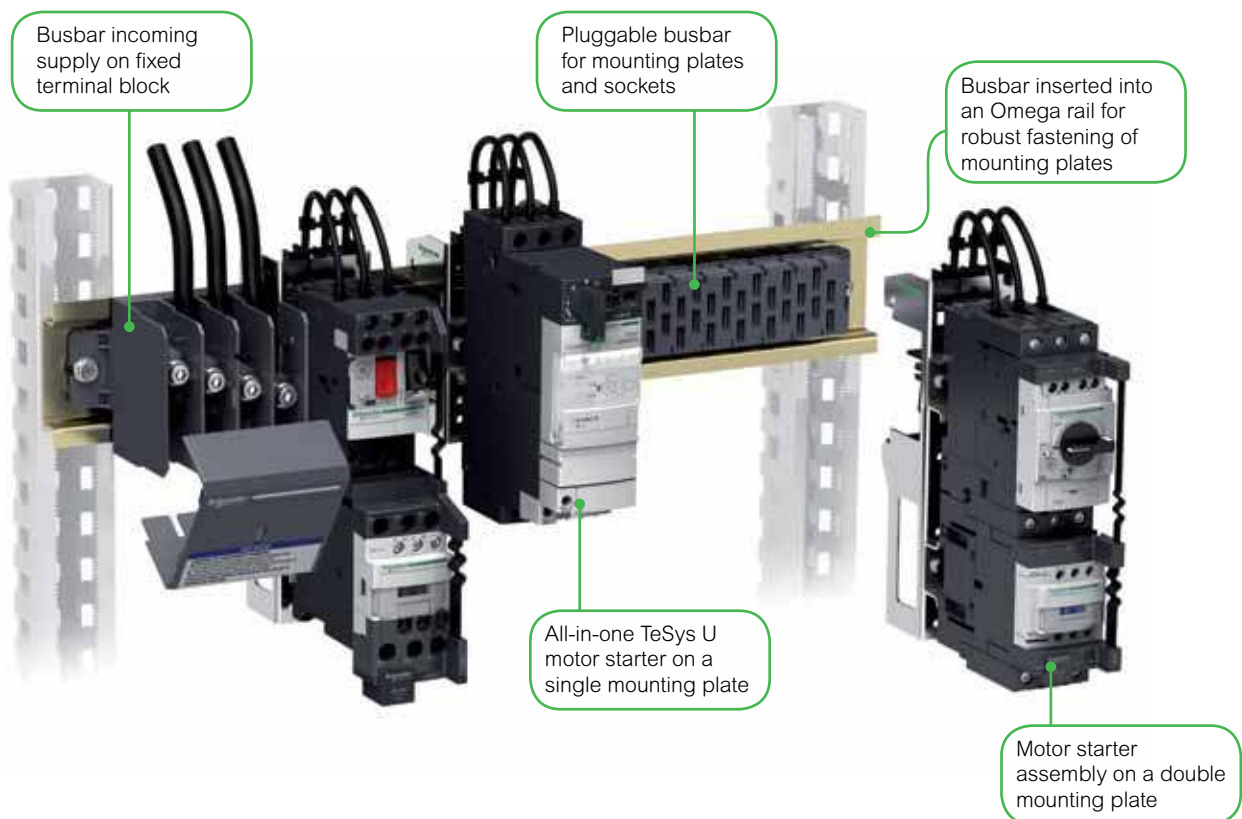

TeSys GV

Adapter plates, comb busbars

Motor starters applications

TeSys GV is intended for compact, modular, Direct-On-Line motor starters composition.

Every starter is composed of:

- 1 LAD311 adapter plate (fixed on 2 parallel DIN rails) + 1 fuse carrier + 1 connector + 1 LC1D contactor

Or

- 1 LAD311 adapter plate (fixed on 2 parallel DIN rails) + 1 GV2 circuit breaker + 1 connector + 1 LC1D contactor.

Adapter plates:

- For up to 32 A fuse or circuit breaker
- Single width (45 mm)
- DIN rail fixing bracket for c. b. + contactor assemblies.

Electrical power distributions applications

TeSys GV comb busbars and connectors offer provides power supply to the directly connected starter assemblies or single fuses or circuit breakers.

Combination blocks provide electrical liaison between fuses/circuit breakers and contactors.

The TeSys GV connection offer is composed of comb busbars, supply terminals, combination modules, adapter plates, combination blocks, protective covers.

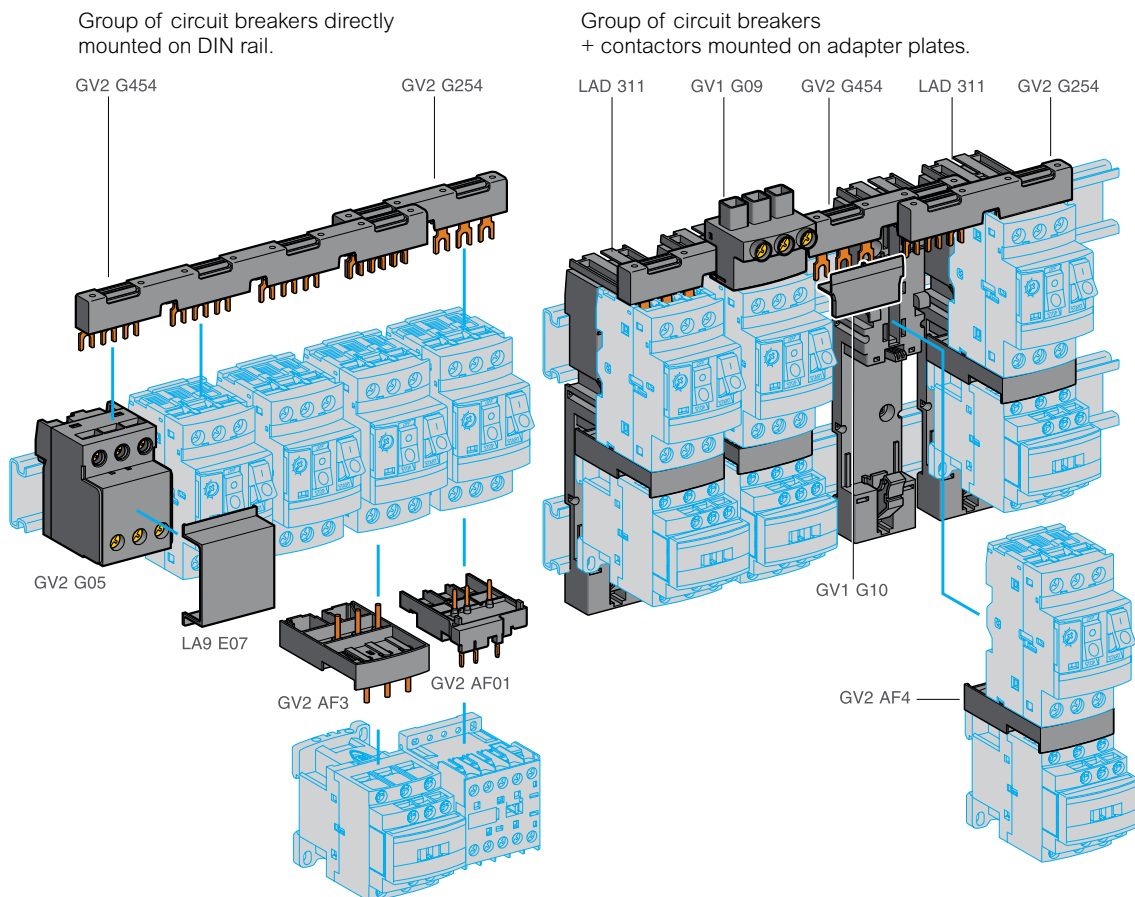

> For more details, download: TeSys – Motor control and protection components catalogue - chapter B2 Catalogue ref MKTED210011EN

Click [HERE](#) for immediate download of Linergy Chapter.

TeSys SoLink

Prefabricated motor starter monitoring/control wiring modules

Motor starters applications

TeSys SoLink is intended for motor starters control and monitoring circuits wiring: Direct-On-Line or reversing.

The main advantages are fast and reliable wiring, immediate connection, disconnection of the circuits by mean of a RJ45 plug.

The control/monitoring RJ45 cables are compatible with various IO modules of the Schneider Electric offer.

Every starter is composed of:

- 1 TeSys SoLink LADC connection module + 1 GV2 or GV3 circuit breaker + 1 GV2AF3 combinaison block + 1 GVAE20 auxiliary contact block + 1 or 2 LC1D contactors.

Connection modules:

- Up to 80 A circuit breakers
- single, double width
- Pin terminals + RJ45 connector.

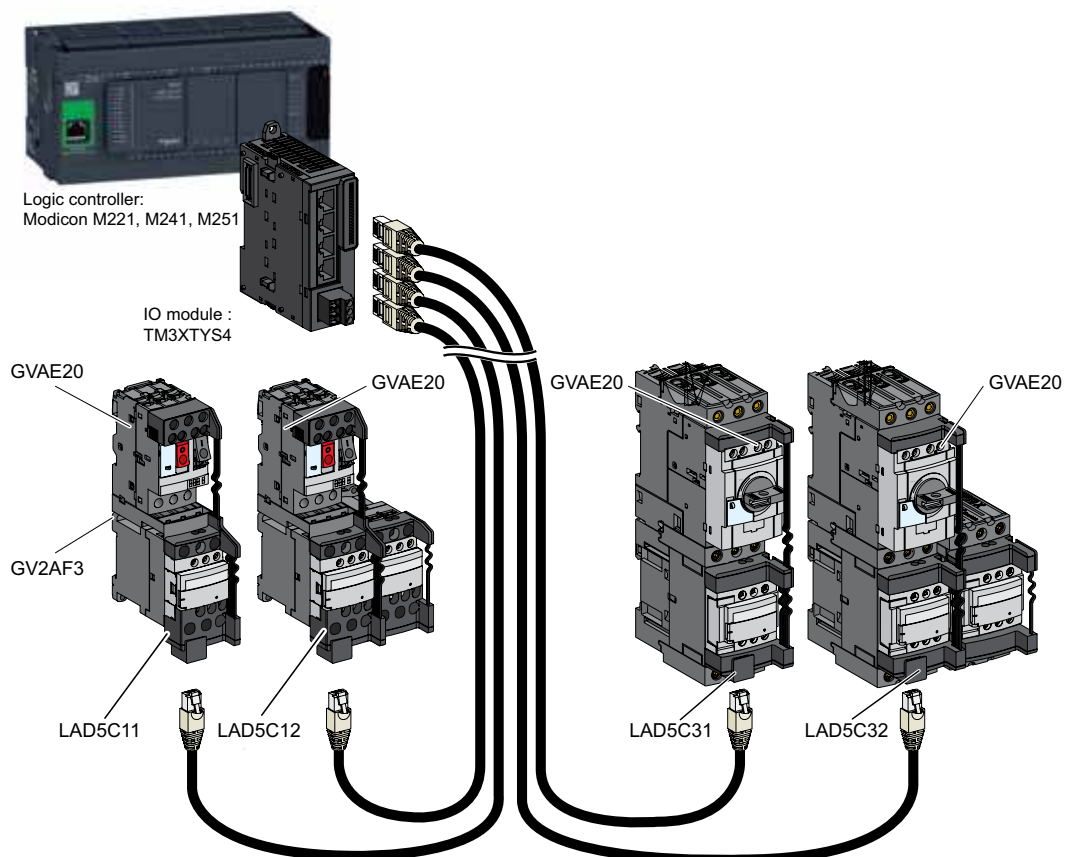

> For more details, download: TeSys – Motor control and protection components catalogue - chapter B2 Catalogue ref MKTED210011EN

Click [HERE](#) for immediate download of Linergy Chapter.

Coordinated Starters Selection tables

Coordinated starter solutions

Starters with NFC, DIN fuses type aM.....	24 to 26
Starters with BS fuses.....	27
Starters with built-in thermal overload protection circuit breaker.....	28
Starters with circuit breaker and thermal overload relay.....	29 to 30

TeSys motor starters - open version

D.O.L starters with fuse protection (NF C or DIN fuses, type aM)

0.06 to 55 kW at 400/415 V: type 1 coordination											
Standard power ratings of 3-phase motors 50/60 Hz in category AC-3						Fuse carrier ⁽¹⁾ (basic block)	aM fuses		Contactor	Thermal overload relay classe 10	
400/415 V		440 V		500 V		Reference	Size	Rating	Reference ⁽²⁾	Reference	Setting range
P	I _e	P	I _e	P	I _e			A			A
kW	A	kW	A	kW	A						A
5.5	11.5	5.5	10.4	7.5	12.4	LS1D32	10 x 38	16	LC1K12	LR2K0321	10...14
7.5	15.5	7.5	13.7	9	13.9	LS1D32	10 x 38	16	LC1D18	LRD21	12...18
-	-	9	16.9	-	-	LS1D32	10 x 38	20	LC1D25	LRD21	12...18
9	18.1	-	-	11	17.6						
11	22	11	20.1	15	23	GK1EK	14 x 51	25	LC1D25	LRD22	16...24
15	29	15	26.5	18.5	28	GK1EK	14 x 51	32	LC1D32	LRD32	23...32
18.5	35	18.5	32.8	22	33	GK1EK	14 x 51	40	LC1D40	LRD3355	30...40
22	41	22	39	30	44	GS●J	22 x 58	50	LC1D50A	LRD350	37...50
-	-	30	51.5	-	-	GS●J	22 x 58	80	LC1D50A	LRD365	48...65
-	-	-	-	37	53	GS●J	22 x 58	80	LC1D65A	LRD365	48...65
30	55	37	64	-	-	GS●J	22 x 58	80	LC1D65A	LRD365	48...65
37 ⁽³⁾	66	45	76	-	-	GS●J	22 x 58	100	LC1D80	LRD3363	63...80
45	80	-	-	55	78	GS●J	22 x 58	100	LC1D95	LRD3365	80...93
-	-	55	90	-	-	GS●J	22 x 58	125	LC1D115	LRD4365	80...104
55	97	-	-	75	106	GS●J	22 x 58	125	LC1D115	LRD4367	95...120

(1) For breaking under load, add a rotary switch-disconnector.

(2) For reversing operation, replace the prefix LC1 with LC2.

(3) 440 V maximum.

TeSys motor starters - open version

D.O.L starters with fuse protection (NF C or DIN fuses, type aM)

0.06 to 315 kW at 400/415 V: type 2 coordination											
Standard power ratings of 3-phase motors 50/60 Hz in category AC-3						Switch-disconnector	aM fuses		Contactor	Thermal overload relay classe 10	
400/415 V		440 V		500 V		Reference ⁽¹⁾	Size	Rating	Reference ⁽²⁾	Reference	Setting range
P	I _e	P	I _e	P	I _e			A			A
kW	A	kW	A	kW	A						
0.06	0.2	0.06	0.19	–	–	GS1DD	10 x 38	2	LC1D09	LRD02	0.16...0.25
–	–	0.09	0.28	–	–	GS1DD	10 x 38	2	LC1D09	LRD03	0.25...0.4
0.09	0.3	–	–	–	–						
0.12	0.44	0.12	0.37	–	–	GS1DD	10 x 38	2	LC1D09	LRD04	0.4...0.63
0.18	0.6	0.18	0.55	–	–						
–	–	0.25	0.76	–	–	GS1DD	10 x 38	2	LC1D09	LRD05	0.63...1
0.25	0.85	–	–	0.37	0.88						
0.37	1.1	0.37	1	0.55	1.2						
0.55	1.5	0.55	1.36	0.75	1.5	GS1DD	10 x 38	2	LC1D09	LRD06	1...1.7
0.75	1.9	0.75	1.68	–	–						
–	–	1.1	2.37	1.1	2.2	GS1DD	10 x 38	4	LC1D09	LRD07	1.6...2.5
1.1	2.7	–	–	1.5	2.9						
1.5	3.6	1.5	3.06	2.2	3.9	GS1DD	10 x 38	4	LC1D09	LRD08	2.5...4
2.2	4.9	2.2	4.42	3	5.2	GS1DD	10 x 38	6	LC1D09	LRD10	4...6
3	6.5	3	5.77	4	6.8	GS1DD	10 x 38	8	LC1D09	LRD12	5.5...8
4	8.5	4	7.9	5.5	9.2	GS1DD	10 x 38	10	LC1D09	LRD14	7...10
5.5	11.5	5.5	10.4	7.5	12.4	GS1DD	10 x 38	16	LC1D12	LRD16	9...13
7.5	15.5	7.5	13.7	9	13.9	GS1DD	10 x 38	16	LC1D18	LRD21	12...18
–	–	9	16.9	–	–	GS●F	14 x 51	20	LC1D25	LRD21	12...18
9	18.1	11	20.1	11	17.6						
11	22	–	–	15	23	GS●F	14 x 51	25	LC1D25	LRD22	16...24
15	29	15	26.5	18.5	28	GS●F	14 x 51	32	LC1D32	LRD32	23...32
18.5	35	18.5	32.8	22	33	GS●F	14 x 51	40	LC1D40A	LRD340	30...40
22	41	22	39	30	44	GS●J	22 x 58	50	LC1D50A	LRD350	37...50
–	–	30	51.5	–	–	GS●J	22 x 58	80	LC1D65A	LRD365	48...65
–	–	–	–	37	53	GS●J	22 x 58	80	LC1D65A	LRD365	48...65
30	55	37	64	–	–	GS●J	22 x 58	80	LC1D65A	LRD365	48...65
–	–	–	–	45	64	GS●J	22 x 58	80	LC1D95	LRD3361	55...70
–	–	–	–	55	78	GS●J	22 x 58	100	LC1D115	LR9D5367	60...100
45	80	–	–	–	–	GS●J	22 x 58	100	LC1D95	LRD3365	80...93
55	97	55	90	75	106	GS●L	T0	125	LC1D150	LR9D5369	90...150
75	132	75	125	90	128	GS●L	T0	160	LC1D150	LR9D5369	90...150
90	160	90	146	110	156	GS●N	T1	200	LC1F185	LR9F5371	132...220
110	195	110	178	132	184	GS●N	T1	250	LC1F225	LR9F5371	132...220
132	230	132	215	160	224	GS●QQ	T2	315	LC1F265	LR9F7375	200...330
–	–	160	256	–	–	GS●QQ	T2	315	LC1F330	LR9F7375	200...330
160	280	200	321	200	280	GS●QQ	T2	400	LC1F330	LR9F7375	200...330
–	–	–	–	220	310	GS●QQ	T2	400	LC1F400	LR9F7375	200...330
200	350	–	–	–	–						
220	388	220	353	250	344	GS2S	T3	500	LC1F400	LR9F7379	300...500
250	430	250	401	–	–	GS2S	T3	500	LC1F500	LR9F7379	300...500
–	–	–	–	315	432						
–	–	–	–	355	488	GS2S	T3	630	LC1F500	LR9F7381	380...630
315	540	315	505	–	–	GS2S	T3	630	LC1F630	LR9F7381	380...630
–	–	355	549	–	–						
–	–	400	611	400	552	GS2V	T4	800	LC1F630	LR9F7381	380...630

(1) GS●: GS1 for direct operator or GS2 for external operator.

(2) For reversing operation, replace the prefix LC1 with LC2.

TeSys motor starters - open version

D.O.L starters with fuse protection (NF C or DIN fuses, type aM)

0.75 to 400 kW at 690 V: type 2 coordination							
Standard power ratings of 3-phase motors 50/60 Hz in category AC-3		Switch-disconnector	aM fuses		Contactor	Thermal overload relay classe 10	
P	I _e	Reference ⁽¹⁾	Size	Rating	Reference ⁽²⁾	Reference	Setting range
kW	A			A			A
0.75	1.1	GS●F	14 x 51	2	LC1D09	LRD06	1...1.6
1.1	1.6	GS●F	14 x 51	2	LC1D09	LRD06	1...1.6
1.5	2.1	GS●F	14 x 51	4	LC1D09	LRD07	1.6...2.5
2.2	2.8	GS●F	14 x 51	4	LC1D09	LRD08	2.5...4
3	3.8	GS●F	14 x 51	6	LC1D09	LRD08	2.5...4
4	4.9	GS●F	14 x 51	6	LC1D09	LRD10	4...6
5.5	6.7	GS●F	14 x 51	8	LC1D09	LRD12	5.5...8
7.5	8.9	GS●F	14 x 51	10	LC1D25	LRD16	9...13
11	12.8	GS●F	14 x 51	16	LC1D25	LRD16	9...13
15	17	GS●F	14 x 51	20	LC1D25	LRD22	16...24
18.5	21	GS●F	14 x 51	25	LC1D32	LRD22	16...24
22	24	GS●J	22 x 58	32	LC1D40A	LRD332	23...32
30	32	GS●J	22 x 58	40	LC1D40A	LRD340	30...40
37	39	GS●J	22 x 58	50	LC1D65A	LRD350	37...50
55	57	GS●J	22 x 58	80	LC1D115	LR2D3359	48...65
75	77	GS●KK	T00	100	LC1D115	LR2D3363	63...80
90	93	GS●KK	T00	125	LC1D150	LR9D5369	90...150
110	113	GS●KK	T00	125	LC1F185	LR9D5369	90...150
132	134	GS●L	T0	160	LC1F265	LR9F5371	132...220
160	162	GS●N	T1	200	LC1F265	LR9F5371	132...220
200	203	GS●N	T1	250	LC1F330	LR9F7375	200...330
220	224	GS●QQ	T2	250	LC1F400	LR9F7375	200...330
250	250	GS●QQ	T2	315	LC1F400	LR9F7375	200...330
315	313	GS●QQ	T2	355	LC1F500	LR9F7379	300...500
355	354	GS●QQ	T2	400	LC1F630	LR9F7379	300...500
400	400	GS2S	T3	500	LC1F630	LR9F7379	300...500

(1) GS●: GS1 for direct operator or GS2 for external operator.

(2) For reversing operation, replace the prefix LC1 with LC2.

TeSys motor starters - open version

D.O.L. starters with fuse protection (BS fuses)

0.06 to 375 kW at 415 V: type 2 coordination											
Standard power ratings of 3-phase motors 50/60 Hz in category AC-3						Switch-disconnector-fuse	BS fuses		Contactor	Thermal overload relay	
415 V		440 V		500 V		Reference	Size	Rating	Reference ⁽¹⁾	Reference	Setting range
P	I _e	P	I _e	P	I _e						
kW	A	kW	A	kW	A		A			A	
0.06	0.22	0.06	0.19	–	–	GS1DDB	A1	NIT 2	LC1D09	LRD02	0.16...0.25
–	–	0.09	0.28	–	–	GS1DDB	A1	NIT 2	LC1D09	LRD03	0.25...0.4
0.09	0.36	–	–	–	–						
0.12	0.42	0.12	0.37	–	–	GS1DDB	A1	NIT 2	LC1D09	LRD04	0.4...0.63
0.18	0.6	0.18	0.55	–	–	GS1DDB	A1	NIT 2	LC1D09	LRD05	0.63...1
–	–	0.25	0.76	–	–	GS1DDB	A1	NIT 4	LC1D09	LRD05	0.63...1
0.25	0.88	0.37	1	0.37	1						
0.37	1	0.55	1.36	0.55	1.2						
0.55	1.5	0.75	1.68	0.75	1.5	GS1DDB	A1	NIT 6	LC1D09	LRD06	1...1.7
0.75	2	–	–	–	–	GS1DDB	A1	NIT 10	LC1D09	LRD07	1.6...2.5
–	–	–	–	1.5	2.6	GS1DDB	A1	NIT 10	LC1D09	LRD08	2.5...4
1.5	3.5	1.5	3.06	2.2	3.8	GS1DDB	A1	NIT 16	LC1D09	LRD08	2.5...4
2.2	5	2.2	4.42	3	5	GS1DDB	A1	NIT 16	LC1D09	LRD10	4...6
3	6.5	3	5.77	4	6.5	GS1DDB	A1	NIT 20	LC1D09	LRD12	5.5...8
4	8.4	4	7.9	5.5	9	GS1DDB	A1	NIT 20	LC1D09	LRD14	7...10
5.5	11	5.5	10.4	7.5	12	GS1DDB	A1	NIT 20M25	LC1D12	LRD16	9...13
7.5	14	7.5	13.7	9	13.9	GS1DDB	A1	NIT 20M32	LC1D18	LRD21	12...18
9	18.1	9	16.9	–	–	GS2GB	A2	TIA 32M35	LC1D18	LRD21	12...18
11	21	11	20	11	18.4						
–	–	–	–	15	23	GS2GB	A2	TIA 32M50	LC1D25	LRD22	16...24
15	28.5	15	26.5	–	–	GS2GB	A2	TIA 32M63	LC1D32	LRD32	23...32
–	–	–	–	22	33	GS2GB	A3	TIS 63M80	LC1D40	LRD3355	30...40
22	42	22	39	30	45	GS2GB	A3	TIS 63M100	LC1D50	LRD3357	37...50
–	–	30	51.5	–	–	GS2GB	A3	TIS 63M100	LC1D50	LRD3359	48...65
30	57	–	–	–	–	GS2GB	A3	TIS 63M100	LC1D65	LRD3359	48...65
45	81	–	–	55	80	GS2LLB	A4	TCP 100M125	LC1D95	LRD3365	80...93
55	100	–	–	–	–	GS2LLB	A4	TCP 100M160	LC1D115	LR9D5369	90...150
–	–	55	90	–	–	GS2LLB	A4	TCP 100M160	LC1D115	LR9D5367	60...100
–	–	–	–	80	116	GS2LB	B2	TF 200	LC1D150	LR9D5369	90...150
80	138	80	132	–	–	GS2LB	B2	TF 200M250	LC1D150	LR9D5369	90...150
–	–	–	–	100	143						
–	–	–	–	110	156	GS2LB	B2	TF 200M250	LC1F185	LR9F5371	132...220
100	182	100	162	–	–	GS2MMB	B2	TF 200M250	LC1F185	LR9F5371	132...220
110	196	110	178	–	–	GS2MMB	B2	TF 200M315	LC1F225	LR9F5371	132...220
–	–	–	–	140	200	GS2NB	B3	TKF 315M355	LC1F265	LR9F5371	132...220
140	250	140	226	160	220	GS2NB	B3	TKF 315M355	LC1F265	LR9F7375	200...330
160	285	160	256	–	–	GS2QQB	B4	TKF 315M355	LC1F330	LR9F7375	200...330
–	–	–	–	220	310	GS2QQB	B4	TMF 400	LC1F400	LR9F7379	300...500
220	388	220	353	257	362	GS2QQB	B4	TMF 400M450	LC1F400	LR9F7379	300...500
–	–	–	–	270	380	GS2SB	C2	TTM 500	LC1F500	LR9F7379	300...500
257	450	257	412	–	–						
270	460	270	433	–	–	GS2SB	C2	TTM 500	LC1F500	LR9F7381	380...630
375	610	375	577	375	508						
–	–	–	–	425	556	GS2SB	C2	TTM 630	LC1F630	LR9F7381	380...630

(1) For reversing operation, replace the prefix LC1 with LC2.

TeSys motor starters - open version

D.O.L. starters with circuit breaker

and overload protection built into the circuit breaker

0.06 to 110 kW at 400/415 V: type 1 coordination											
Standard power ratings of 3-phase motors 50/60 Hz in category AC-3									Circuit breaker		Contactor
400/415 V			440 V			500 V			Reference	Setting range of thermal trips	Reference ⁽²⁾
P	I _e	I _q ⁽¹⁾	P	I _e	I _q ⁽¹⁾	P	I _e	I _q ⁽¹⁾		A	
kW	A	kA	kW	A	kA	kW	A	kA			
0.06	0.2	50	0.06	0.19	50	–	–	–	GV2ME02	0.16...0.25	LC1K06 or LC1D09
0.09	0.3	50	0.09 0.12	0.28 0.37	50 50	–	–	–	GV2ME03	0.25...0.40	LC1K06 or LC1D09
0.12	0.44	50	–	–	–	–	–	–	GV2ME04	0.40...0.63	LC1K06 or LC1D09
0.18	0.6	50	0.18	0.55	50	–	–	–	GV2ME05	0.63...1	LC1K06 or LC1D09
0.25	0.85	50	0.25	0.76	50	–	–	–	GV2ME06	1...1.6	LC1K06 or LC1D09
0.37	1.1	50	0.37	0.99	50	–	–	–	GV2ME06	1...1.6	LC1K06 or LC1D09
–	–	–	–	–	–	0.37	0.88	50	GV2ME06	1...1.6	LC1K06 or LC1D09
0.55	1.5	50	0.55	1.36	50	0.55	1.2	50	GV2ME06	1...1.6	LC1K06 or LC1D09
–	–	–	–	–	–	0.75	1.5	50	GV2ME06	1...1.6	LC1K06 or LC1D09
0.75	1.9	50	0.75	1.68	50	–	–	–	GV2ME07	1.6...2.5	LC1K06 or LC1D09
–	–	–	1.1	2.37	50	1.1	2.2	50	GV2ME07	1.6...2.5	LC1K06 or LC1D09
1.1	2.7	50	–	–	–	1.5	2.9	50	GV2ME08	2.5...4	LC1K06 or LC1D09
1.5	3.6	50	1.5	3.06	50	2.2	3.9	50	GV2ME08	2.5...4	LC1K06 or LC1D09
2.2	4.9	50	2.2	4.42	50	–	–	–	GV2ME10	4...6.3	LC1K06 or LC1D09
–	–	–	3	5.77	50	3	5.2	50	GV2ME10	4...6.3	LC1K06 or LC1D09
3	6.5	50	–	–	–	4	6.8	10	GV2ME14	6...10	LC1K09 or LC1D09
4	8.5	50	4	7.9	15	5.5	9.2	10	GV2ME14	6...10	LC1K09 or LC1D09
5.5	11.5	15	5.5	10.4	8	7.5	12.4	6	GV2ME16	9...14	LC1K12 or LC1D12
7.5	15.5	15	7.5	13.7	8	9	13.9	6	GV2ME20	13...18	LC1D18
–	–	–	9	16.9	8	–	–	–	GV2ME20	13...18	LC1D18
9	18.1	15	11	20.1	6	11	17.6	4	GV2ME21	17...23	LC1D25
11	22	15	–	–	–	15	23	4	GV2ME22	20...25	LC1D25
15	29	10	15	26.5	6	18.5	28	4	GV2ME32	24...32	LC1D32
18.5	35	50	18.5	32.8	50	22	33	10	GV3P40	30...40	LC1D40A
22	41	50	22	39	50	30	44	10	GV3P50	37...50	LC1D50A
30	55	50	37	51.5	50	37	53	10	GV3P65	48...65	LC1D65A
–	–	–	37	64	25	45	64	18	GV7RE80	48...80	LC1D65A
45	80	25	–	–	–	–	–	–	GV7RE100	60...100	LC1D95
–	–	–	50	90	25	–	–	–	GV7RE100	60...100	LC1D115
55	97	25	–	–	–	75	106	30	GV7RE150	90...150	LC1D115
75	132	35	75	125	35	90	128	30	GV7RE150	90...150	LC1D150
–	–	–	90	146	35	–	–	–	GV7RE150	90...150	LC1F185
90	160	35	–	–	–	110	156	30	GV7RE220	132...220	LC1F185
–	–	–	–	–	–	132	184	30	GV7RE220	132...220	LC1F265
–	–	–	110	178	35	160	224	30	GV7RE220	132...220	LC1F265
110	195	35	132	215	35	–	–	–	GV7RE220	132...220	LC1F225

(1) The breaking performance of circuit breakers GV2 ME can be increased by adding a current limiter GV1 L3, see page 24509/5.

(2) For reversing operation, replace the prefix LC1 with LC2.

TeSys motor starters - open version

D.O.L. starters with circuit breaker

and overload protection by separate thermal overload relay

0.06 to 250 kW at 400/415 V: type 1 coordination														
Standard power ratings of 3-phase motors 50/60 Hz in category AC-3									Circuit breaker			Contactor	Thermal overload relay	
400/415 V			440 V			500 V			Reference	Rating	I _{rm} ⁽¹⁾	Reference ⁽²⁾	Reference	Setting range
P	I _e	I _q	P	I _e	I _q	P	I _e	I _q		A	A			A
kW	A	kA	kW	A	kA	kW	A	kA						
0.06	0.2	50	0.06	0.19	50	-	-	-	GV2LE03	0.4	5	LC1K06	LR2K0302	0.16...0.23
-	-	-	0.09	0.28	50	-	-	-	GV2LE03	0.4	5	LC1K06	LR2K0303	0.23...0.36
0.09	0.3	50	0.12	0.37	50	-	-	-	GV2LE03	0.4	5	LC1K06	LR2K0304	0.36...0.54
0.12	0.44	50	-	-	-	-	-	-	GV2LE04	0.63	8	LC1K06	LR2K0304	0.36...0.54
0.18	0.6	50	0.18	0.55	50	-	-	-	GV2LE04	0.63	8	LC1K06	LR2K0305	0.54...0.8
-	-	-	0.25	0.76	50	-	-	-	GV2LE05	1	13	LC1K06	LR2K0305	0.54...0.8
0.25	0.85	50	-	-	-	-	-	-	GV2LE05	1	13	LC1K06	LR2K0306	0.8...1.2
0.37	1.1	50	0.37	1	50	0.37	0.88	50	GV2LE05	1	13	LC1K06	LR2K0306	0.8...1.2
0.55	1.5	50	0.55	1.36	50	0.55	1.2	50	GV2LE06	1.6	22.5	LC1K06	LR2K0307	1.2...1.8
-	-	-	-	-	-	0.75	1.5	50	GV2LE06	1.6	22.5	LC1K06	LR2K0307	1.2...1.8
-	-	-	0.75	1.68	50	-	-	-	GV2LE07	2.5	33.5	LC1K06	LR2K0307	1.2...1.8
0.75	1.9	50	-	-	-	-	-	-	GV2LE07	2.5	33.5	LC1K06	LR2K0308	1.8...2.6
1.1	2.7	50	1.1	2.37	50	1.1	2.2	50	GV2LE07	2.5	33.5	LC1K06	LR2K0308	1.8...2.6
1.5	3.6	50	1.5	3.06	50	1.5	2.9	50	GV2LE08	4	51	LC1K06	LR2K0310	2.6...3.7
-	-	-	-	-	-	2.2	3.9	50	GV2LE08	4	51	LC1K06	LR2K0312	3.7...5.5
2.2	4.9	50	2.2	4.4	50	3	5.2	50	GV2LE10	6.3	78	LC1K06	LR2K0312	3.7...5.5
-	-	-	3	5.77	50	-	-	-	GV2LE10	6.3	78	LC1K06	LR2K0314	5.5...8
-	-	-	4	7.9	15	-	-	-	GV2LE14	10	138	LC1K09	LR2K0314	5.5...8
3	6.5	50	-	-	-	4	6.8	10	GV2LE14	10	138	LC1K09	LR2K0314	5.5...8
4	8.5	50	-	-	-	-	-	-	GV2LE14	10	138	LC1K09	LR2K0316	8...11.5
5.5	11.5	15	5.5	10.4	8	7.5	12.4	6	GV2LE16	14	170	LC1K12	LR2K0321	10...14
-	-	-	7.5	13.7	8	9	13.9	6	GV2LE16	14	170	LC1D18	LRD21	12...18
7.5	15.5	15	9	16.9	8	-	-	-	GV2LE20	18	223	LC1D18	LRD21	12...18
9	18.1	15	-	-	-	11	17.6	4	GV2LE22	25	327	LC1D25	LRD22	16...24
11	22	15	11	20.1	6	15	23	4	GV2LE22	25	327	LC1D25	LRD22	16...24
15	29	10	15	26.5	6	18.5	28	4	GV2LE32	32	416	LC1D32	LRD32	23...32
18.5	35	50	18.5	32.5	50	22	33	10	GV3L40	40	560	LC1D40A	LRD340	30...40
22	41	50	22	39	50	30	44	10	GV3L50	50	700	LC1D50A	LRD350	37...50

(1) I_{rm}: setting current of the magnetic trip.
 (2) For reversing operation, replace the prefix LC1 with LC2.

TeSys motor starters - open version

D.O.L. starters with circuit breaker

and overload protection by separate thermal overload relay

0.06 to 250 kW at 400/415 V: type 1 coordination														
Standard power ratings of 3-phase motors 50/60 Hz in category AC-3									Circuit breaker			Contactor	Thermal overload relay	
400/415 V			440 V			500 V			Reference	Rating I _{rm} ⁽¹⁾		Reference ⁽²⁾	Reference	Setting range
P	I _e	I _q	P	I _e	I _q	P	I _e	I _q		A	A			A
kW	A	kA	kW	A	kA	kW	A	kA						
30	55	50	37	51.5	50	37	53	10	GV3L65	65	910	LC1D65A	LRD365	48...65
-	-	-	37	64	50	37	53	10	GV3L65	65	910	LC1D65A	LRD365	48...65
45	80	⁽³⁾	-	-	-	-	-	-	NSX100●MA ⁽³⁾	100	1300	LC1D95	LRD3365	80...104
-	-	-	-	-	-	50	90	⁽³⁾	NSX100●MA ⁽³⁾	100	1200	LC1D115	LRD4365	80...104
-	-	-	-	-	-	75	106	⁽³⁾	NSX160●MA ⁽³⁾	150	1500	LC1D115	LRD4367	95...120
55	97	⁽³⁾	-	-	-	-	-	-	NSX160●MA ⁽³⁾	150	1350	LC1D115	LRD4367	95...120
75	132	⁽³⁾	75	125	⁽³⁾	90	128	⁽³⁾	NSX160●MA ⁽³⁾	150	1800	LC1D150	LRD4369	110...140
-	-	-	90	146	⁽³⁾	-	-	-	NSX160●MA ⁽³⁾	150	1950	LC1F185	LR9F5371	132...220
90	160	⁽³⁾	-	-	-	110	156	⁽³⁾	NSX250●MA ⁽³⁾	220	2200	LC1F185	LR9F5371	132...220
110	195	⁽³⁾	-	-	-	-	-	-	NSX250●MA ⁽³⁾	220	2640	LC1F225	LR9F5371	132...220
-	-	-	110	178	⁽³⁾	-	-	-	NSX250●MA ⁽³⁾	220	2420	LC1F225	LR9F5371	132...220
-	-	-	-	-	-	132	184	⁽³⁾	NSX250●MA ⁽³⁾	220	2640	LC1F265	LR9F5371	132...220
-	-	-	132	215	⁽³⁾	-	-	-	NSX250●MA ⁽³⁾	220	2860	LC1F265	LR9F5371	132...220
132	230	⁽³⁾	-	-	-	-	-	-	NSX400●+ Micrologic 1.3M ⁽³⁾	320	3200	LC1F265	LR9F7375	200...330
-	-	-	-	-	-	160	224	⁽³⁾	NSX400●+ Micrologic 1.3M ⁽³⁾	320	2860	LC1F265	LR9F7375	200...330
-	-	-	160	256	⁽³⁾	-	-	-	NSX400●+ Micrologic 1.3M ⁽³⁾	320	3520	LC1F330	LR9F7375	200...330
160	280	⁽³⁾	200	321	⁽³⁾	-	-	-	NSX400●+ Micrologic 1.3M ⁽³⁾	320	4160	LC1F330	LR9F7375	200...330
-	-	-	-	-	-	200	280	⁽³⁾	NSX400●+ Micrologic 1.3M ⁽³⁾	320	3840	LC1F330	LR9F7375	200...330
-	-	-	-	-	-	220	310	⁽³⁾	NSX400●+ Micrologic 1.3M ⁽³⁾	320	4160	LC1F400	LR9F7379	300...500
200	350	⁽³⁾	220	353	⁽³⁾	-	-	-	NSX630●+ Micrologic 1.3M ⁽³⁾	500	5000	LC1F400	LR9F7379	300...500
-	-	-	250	401	⁽³⁾	-	-	-	NSX630●+ Micrologic 1.3M ⁽³⁾	500	5550	LC1F400	LR9F7379	300...500
-	-	-	-	-	-	250	344	⁽³⁾	NSX630●+ Micrologic 1.3M ⁽³⁾	500	5000	LC1F400	LR9F7379	300...500
220	388	⁽³⁾	-	-	-	-	-	-	NSX630●+ Micrologic 1.3M ⁽³⁾	500	5500	LC1F400	LR9F7379	300...500
250	430	⁽³⁾	280	470	⁽³⁾	315	432	⁽³⁾	NSX630●+ Micrologic 1.3M ⁽³⁾	500	6000	LC1F500	LR9F7379	300...500
-	-	-	-	-	-	355	488	⁽³⁾	NSX630●+ Micrologic 1.3M ⁽³⁾	500	6500	LC1F500	LR9F7381	380...630

(1) I_{rm}: setting current of the magnetic trip.

(2) For reversing operation, replace the prefix LC1 with LC2.

(3) Reference to be completed by replacing the ● with the breaking performance code:

Breaking performance I _q (kA)	NSX100●MA		NSX160●MA and NSX250●MA		NSX400● and NSX630●
400/415 V	36	70	36	70	150
440 V	35	65	35	65	130
500 V	25	50	25	50	70
660/690 V	8	10	8	10	20
Code	F	H	F	H	L

Technical Data for Designers

Contents

TeSys D Green – contactors

Characteristics	34 to 37
Dimensions.....	38
Mounting.....	39 to 40
Schemes.....	41 to 42

TeSys D Green – reversing contactors

Dimensions.....	43
Schemes.....	44

Characteristics

TeSys D Green

Contactors with AC/DC coil

Environment			D09...D18	D25...D38	D40A...D65A DT60A and DT80A	D80A
Rated insulation voltage (Ui)	Conforming to IEC 60947-4-1, overvoltage category III, degree of pollution: 3	V	690			1000
	Conforming to UL, CSA	V	600			
Rated impulse withstand voltage (Uimp)	Conforming to IEC 60947	kV	6			8
Conforming to standards			IEC/EN 60947-4-1, IEC/EN 60947-5-1, UL 508, CSA C22.2 n°14.			
Product certifications			UL ⁽¹⁾			
Degree of protection ⁽²⁾ (front face)	Conforming to IEC 60529					
	Power circuit connections		Protection against direct finger contact IP20			
	Coil connection		Protection against direct finger contact IP20			
Protective treatment	Conforming to IEC 60068-2-30		"TH"			
Ambient air temperature around the device	Storage	°C	-60...+80			
	Operation	°C	-5...+60			
	Permissible	°C	-40...+70, for operation at U _c			
Maximum operating altitude	Without derating	m	3000			
Operating positions ⁽³⁾	Without derating in the following positions		<p>AC/DC</p>			
Flame resistance	Conforming to UL 94		V1			
	Conforming to IEC 60695-2-1	°C	850			
Shock resistance ⁽⁴⁾ 1/2 sine wave = 11 ms	Contactor open		10 gn	8 gn	10 gn	8 gn
	Contactor closed		15 gn	15 gn	15 gn	10 gn
Vibration resistance ⁽⁴⁾ 5...300 Hz	Contactor open		2 gn			
	Contactor closed		4 gn	4 gn	4 gn	3 gn

⁽¹⁾ UL certified contactors available mid 2017, other certifications by end of 2017 (see data sheet on our web portal).

⁽²⁾ Protection provided for the cabling c.s.a.'s indicated on the next page and for connection by cable. For lug type: add a protective cover.

⁽³⁾ When mounting on a vertical rail, use a stop.

⁽⁴⁾ Without modifying the contact states, in the most unfavourable direction (coil energised at U_e).

TeSys D Green

Contactors with AC/DC coil

Pole characteristics

Contactor type		LC1	D09 (3P)	D12 (3P)	D18 (3P)	D25 (3P)	
Rated operational current (Ie) (Ue ≤ 440 V)	In AC-3, θ ≤ 60 °C	A	9	12	18	25	
	In AC-1, θ ≤ 60 °C	A	25 ⁽¹⁾	25 ⁽¹⁾	32 ⁽¹⁾	40 ⁽¹⁾	
Rated operational voltage (Ue)	Up to	V	690	690	690	690	
Frequency limits	Of the operational current	Hz	25...400	25...400	25...400	25...400	
Conventional thermal current (Ith)	θ ≤ 60 °C	A	25 ⁽¹⁾	25 ⁽¹⁾	32 ⁽¹⁾	40 ⁽¹⁾	
Rated making capacity (440 V)	Conforming to IEC 60947	A	250	250	300	450	
Rated breaking capacity (440 V)	Conforming to IEC 60947	A	250	250	300	450	
Permissible short time rating No current flowing for preceding 15 minutes with θ ≤ 40 °C	For 1 s	A	210	210	240	380	
	For 10 s	A	105	105	145	240	
	For 1 min	A	61	61	84	120	
	For 10 min	A	30	30	40	50	
Fuse protection against short-circuits (U ≤ 690 V)	Without thermal overload relay, gG fuse	type 1	A	25	40	50	63
		type 2	A	20	25	35	40
	With thermal overload relay	A	See pages B11/4 and B11/5, for aM or gG fuse ratings corresponding to the associated thermal overload relay				
Average impedance per pole	At Ith and 50 Hz	mΩ	2.5	2.5	2.5	2	
Power dissipation per pole for the above operational currents	AC-3	W	0.20	0.36	0.8	1.25	
	AC-1	W	1.56	1.56	2.5	3.2	

Electronic coil circuit characteristics

Rated control circuit voltage (Uc)	V	AC 24...415 V DC 24...500 V
Operation		0.85Uc mini ... 1.1Uc maxi at 60°C in AC or DC
Drop-out		0.1Un max...(eg. 100 to 250 V = 25 V) at 60°C

Associated contactors

T1, T2 (LC1D09 ... D25)

Coil Code		BNE	EHE	KUE	
Coil rating	V	24-60	48-130	100-250	
AC supply at 20 °C	Consumption inrush	VA	15	25	25
	Consumption sealed	VA	1.1	1.4	1.4
	Consumption sealed	mA	28	15	9
	Heat dissipation	W	0.6	0.8	1.1
DC supply at 20 °C	Consumption inrush	W	15	24	18
	Consumption sealed	mA	23	13	7
	Heat dissipation	W	0.7	0.8	1.3
Max operating time ⁽²⁾	Closing «C»	ms	50 ±5 ms		
	Opening «O»	ms	25 ±5 ms		
EMC emission	IEC 60947-4-1 §9.4.3		environment A ⁽¹⁾		
Maximum operating rate at ambient temperature ≤ 60 °C		cycle/h	3600		
Mechanical durability at Uc	In millions of operating cycles		See datasheet in schneider-electric.com website.		

⁽¹⁾ If use environment B, may cause radio interference, an additional mitigation solution could be requested.

⁽²⁾ The closing time "C" is measured from the moment the coil supply is switched on to closure of the main poles. The opening time "O" is measured from the moment the coil supply is switched off to the moment the main poles separate.

Characteristics

TeSys D Green

Contactors with AC/DC coil

D32	D38	D40A	DT60A	D50A	D65A	DT80A	D80A
32	38	40	–	50	65	80	80
50 ⁽¹⁾	50	60	60	80	80	80	80
690	690	690	690	690	690	690	690
25...400	25...400	25...400	25...400	25...400	25...400	25...400	25...400
50	50	60	60	80	80	80	80
550	550	800	800	900	1000	1000	1000
550	550	800	800	900	1000	1100	1100
430	430	720	720	810	900	900	900
260	310	320	320	400	520	520	520
138	150	165	165	208	260	260	160
60	60	72	72	84	110	110	110
63	63	80	80	100	125	125	125
63	63	80	80	100	125	125	125

See pages B11/4 and B11/5 of TeSys global catalogue for aM or gG fuse ratings corresponding to the associated thermal overload relay

2	2	1.5	1.6	1.5	1.5	1.5	1.5
2	3	2.4	–	3.7	6.3	6.3	6.3
5	5	5.4	5.8	9.6	9.6	9.6	9.6

AC 24...415 V DC 24...500 V			AC 24...415 V DC 24...500 V				
0.85Uc mini 1.1Uc maxi at 60°C in AC or DC			0.8Uc mini 1.2Uc maxi at 60 °C		0.85Uc mini 1.1Uc maxi at 60 °C in AC or DC		
0.1Un max...(eg. 100 to 250 V = 25 V)			0.1 Un max...(eg. 100 to 250 V = 25 V)				
T1, T2 (LC1D32...D38)			T3 (LC1D40A...80A, LC1DT60A, LC1DT80A)				
BNE	EHE	KUE	BBE		BNE	EHE	KUE
24-60	48-130	100-250	24 (DC)		24-60	48-130	100-250
15	25	25	-		15	23	18
1.1	1.4	1.4	-		1.2	1.5	1.9
28	15	9	-		35	17	9.5
0.6	0.8	1.1	-		0.8	0.9	1.3
15	24	18	11		16	19	14
23	13	7	20		30	15	7.7
0.7	0.8	1.3	0.5		0.9	0.9	1.4
50 ±5 ms			60 ±5 ms				
25 ± 5 ms			25 ±5 ms				
environment A ⁽¹⁾							
3600							

(1) If use environment classe B, may cause radio interference, an additional mitigation solution could be requested.

(2) The closing time "C" is measured from the moment the coil supply is switched on to closure of the main poles. The opening time "O" is measured from the moment the coil supply is switched off to the moment the main poles separate.

TeSys D Green

Contactors with AC/DC coil

Power circuit connections									
Screw clamp terminal connections									
Contactor type		LC1	D09 and D12	D18 (3P)	D25 (3P)	D32	D38	D18 and D25 (4P)	D40A to D80A DT60A and DT80A ⁽¹⁾
Tightening			Screw clamp terminals					Connector 2 inputs	Screw clamp terminals
Flexible cable without cable end	1 conductor	mm ²	1...4	1.5...6	2.5...10			2.5...10	1...35
	2 conductors	mm ²	1...4	1.5...6	2.5...10			2.5...10	1...25 and 1...35
Flexible cable with cable end	1 conductor	mm ²	1...4	1...6	1...10			2.5...10	1...35
	2 conductors	mm ²	1...2.5	1...4	1.5...6			2.5...10	1...25 and 1...35
Solid cable without cable end	1 conductor	mm ²	1...4	1.5...6	1.5...10			2.5...16	1...35
	2 conductors	mm ²	1...4	1.5...6	2.5...10			2.5...16	1...25 and 1...35
Screwdriver	Philips		N° 2	N° 2	N° 2			N° 2	–
	Flat screwdriver Ø		Ø6	Ø6	Ø6			Ø6	–
Hexagonal key			–	–	–			–	4
Tightening torque		N.m	1.7	1.7	2.5			1.8	5: ≤ 25 mm ² 8: 35 mm ²

Control circuit connections									
Connection by cable (tightening via screw clamps)									
Flexible cable without cable end	1 conductor	mm ²	1...4	1...4	1...4	1...4		1...4	1...4
	2 conductors	mm ²	1...4	1...4	1...4	1...4		1...4	1...4
Flexible cable with cable end	1 conductor	mm ²	1...4	1...4	1...4	1...4		1...4	1...4
	2 conductors	mm ²	1...2.5	1...2.5	1...2.5	1...2.5		1...2.5	1...2.5
Solid cable without cable end	1 conductor	mm ²	1...4	1...4	1...4	1...4		1...4	1...4
	2 conductors	mm ²	1...4	1...4	1...4	1...4		1...4	1...4
Screwdriver	Philips		N° 2	N° 2	N° 2	N° 2		N° 2	N° 2
	Flat screwdriver Ø		Ø6	Ø6	Ø6	Ø6		Ø6	Ø6
Tightening torque		N.m	1.7	1.7	1.7	1.7		1.7	1.7

⁽¹⁾ BTR screws: hexagon socket head. In accordance with local electrical wiring regulations, a size 4 insulated Allen key must be used (reference LAD ALLEN4, see page "References", page 14).

TeSys D Green

Contactors with AC/DC coil

Characteristics of auxiliary contacts incorporated in the contactor			
Mechanically linked contacts	Conforming to IEC 60947-5-1		Each contactor has 2 N/O and N/C contacts mechanically linked on the same movable contact holder
Mirror contact	Conforming to IEC 60947-4-1		The N/C contact on each contactor represents the state of the power contacts and can be connected to a PREVENTA safety module
Rated operational voltage (Ue)	Up to	V	690
Rated insulation voltage (Ui)	Conforming to IEC 60947-1	V	690
	Conforming to UL, CSA	V	600
Conventional thermal current (Ith)	For ambient temperature ≤ 60 °C	A	10
Frequency of the operational current		Hz	25...400
Minimum switching capacity $\lambda = 10^{-8}$	U min	V	17
	I min	mA	5
Short-circuit protection	Conforming to IEC 60947-5-1		gG fuse: 10 A
Rated making capacity	Conforming to IEC 60947-5-1, I rms	A	~: 140, ---: 250
Short-time rating	Permissible for	1 s	A 100
		500 ms	A 120
		100 ms	A 140
Insulation resistance		MΩ	> 10
Non-overlap time	Guaranteed between N/C and N/O contacts	ms	1.5 (on energisation and on de-energisation)

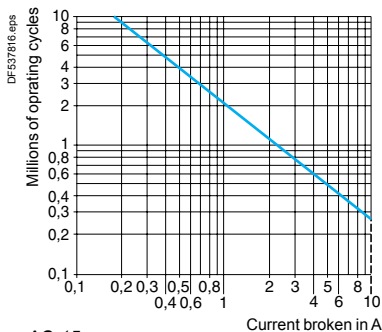

AC-15

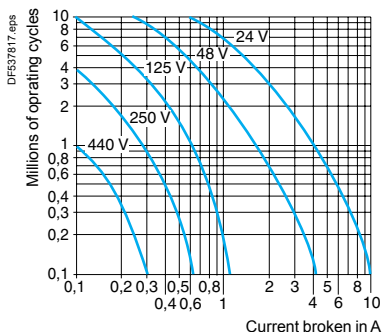

DC-13

Operational power of contacts conforming to IEC 60947-5-1 a.c. supply, categories AC-14 and AC-15

Electrical durability (valid for up to 3600 operating cycles/hour) on an inductive load such as the coil of an electromagnet: making current ($\cos \varphi 0.7$) = 10 times the power broken ($\cos \varphi 0.4$).

Operating cycles	V	24	48	115	230	400	440	600
1 million	VA	60	120	280	560	960	1050	1440
3 million	VA	16	32	80	160	280	300	420
10 million	VA	4	8	20	40	70	80	100

d.c. supply, category DC-13

Electrical durability (valid for up to 1200 operating cycles/hour) on an inductive load such as the coil of an electromagnet, without economy resistor, the time constant increasing with the load.

Operating cycles	V	24	48	125	250	440
1 million	W	96	76	76	76	44
3 million	W	48	38	38	32	—
10 million	W	14	12	12	—	—

Dimensions

TeSys D Green

Contactors with AC/DC coil

LC1 D09...D18 (3-pole), with AC/DC compatible coil

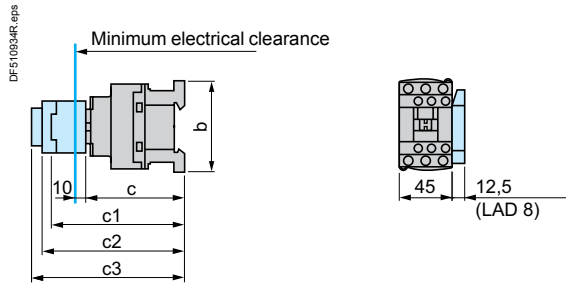

LC1 D25...D38 (3-pole), with AC/DC compatible coil

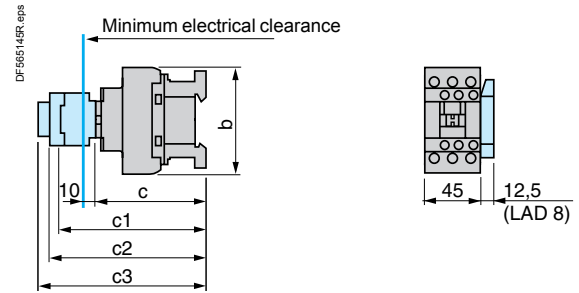

LC1	D09...D18	D25...D38
b without add-on blocks	77	85
c without cover or add-on blocks	84	90
with cover, without add-on blocks	86	92
c1 with LAD N or C (2 or 4 contacts)	117	123
c2 with LA6 DK10	129	135
c3 with LAD T, R, S	137	143
with LAD T, R, S and sealing cover	141	147

LC1 D40A...D80A (3-pole), LC1 DT60A...DT80A (4-pole), with AC/DC compatible coil

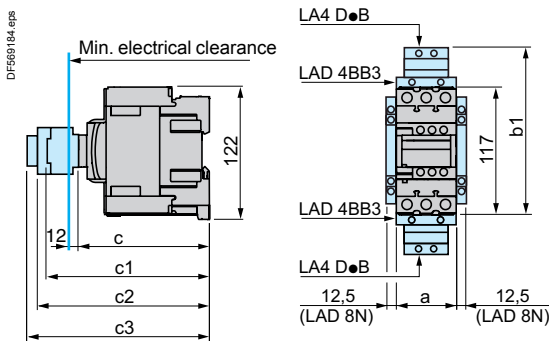

LC1	D40A...D65A	DT60A...DT80A
a	55	70
b1 LAD 4BB3	136	–
with LAD4DWB	166	–
c without cover or add-on blocks	118	118
with cover, without add-on blocks	120	120
c1 with LAD N (1 contact)	–	–
with LAD N or C (2 or 4 contacts)	150	150
c2 with LAD 6K10	163	163
c3 with LAD T, R, S	171	171
with LAD T, R, S and sealing cover	175	175

Mounting

TeSys D Green

Contactors with AC/DC coil

**LC1 D09...D38 (3-pole),
with AC/DC compatible coil**

On mounting rail **AM1 DP200, DR200 or AM1 DE200** (width 35 mm)

8106510.eps

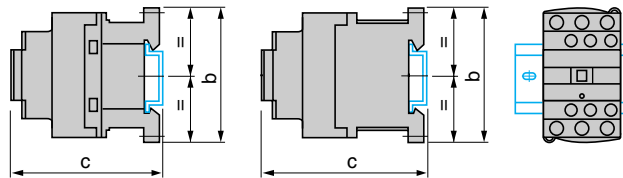

LC1	D09...D18	D25...D38
b	77	85
c (AM1 DP200 or DR200)	88	94
c (AM1 DE200)	96	102

**LC1 D40A...D80A (3-pole), LC1 DT60A and DT80A (4-pole),
with AC/DC compatible coil**

On mounting rail **AM1 DL200 or DL201** (width 75 mm) ⁽²⁾

On mounting rail **AM1 ED●●● or AM1 DE200** (width 35 mm)

DF51103.eps

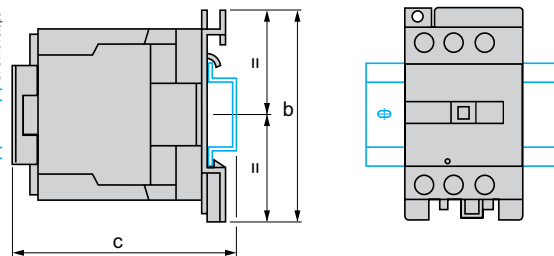

LC1	D40A...D65A DT60A...DT80A
b	122
c (AM1 DL200)	–
c (AM1 DL201)	–
c (AM1 ED●●● or DE200)	128

Mounting

TeSys D Green

Contactors with AC/DC coil

LC1 D09...D38 (3-pole), with AC/DC compatible coil

On 2 mounting rails DZ5 MB

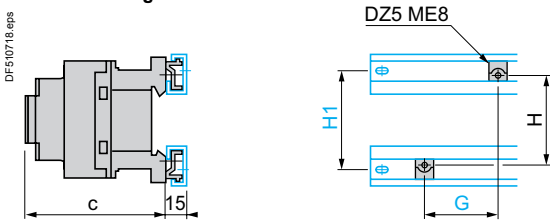

LC1	D09...D18	D25...D38
c with cover	86	92
G	35	35
H	60	60
H1	70	70

LC1 D09...D38 (3-pole), with AC/DC compatible coil

On pre-slotted mounting plate AM1 PA, PB, PC

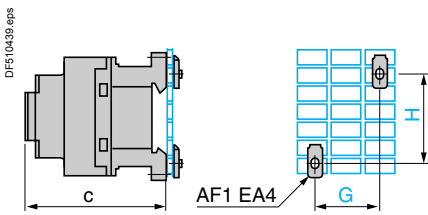

LC1	D09...D18	D25...D38
c with cover	86	92
G	35	35
H	60/70	60/70

LC1 D40A...D80A (3-pole), LC1 DT60A...DT80A (4-pole), with AC/DC compatible coil

On pre-slotted mounting plate AM1 PA, PB, PC and panel mounted

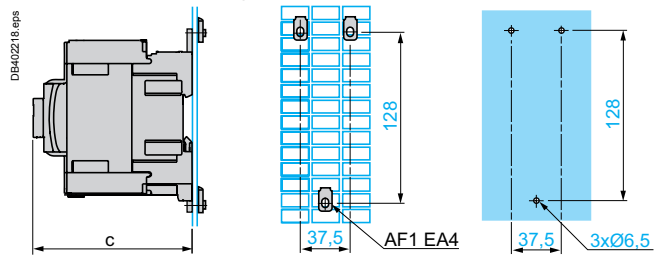

LC1	D40A...D80A, DT60A...DT80A
c with cover	120

LC1 D09...D38 (3-pole), with AC/DC compatible coil

Panel mounted

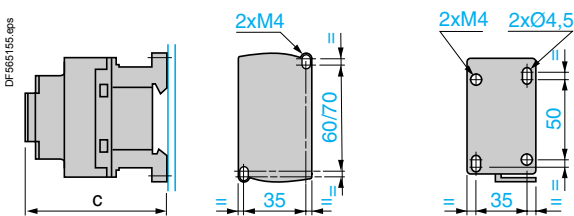

LC1	D09...D18	D25...D38
c with cover	86	92

Contactors

3-pole contactors (References: pages 6 to 9)

LC1 D09 to D80A

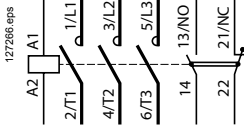

Front mounting add-on contact blocks

Instantaneous auxiliary contacts (References: page 10)

1 N/O LAD N10 ⁽¹⁾

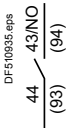

1 N/C LAD N01 ⁽¹⁾

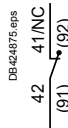

1 N/O + 1 N/C LAD N11

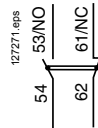

2 N/O LAD N20

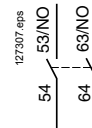

2 N/C LAD N02

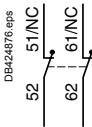

2 N/O + 2 N/C LAD N22

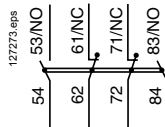

1 N/O + 3 N/C LAD N13

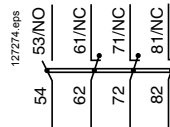

4 N/O LAD N40

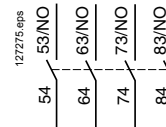

4 N/C LAD N04

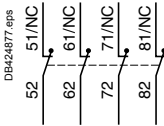

2 N/O + 2 N/C including 1 N/O + 1 N/C make before break LAD C22

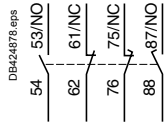

3 N/O + 1 N/C LAD N31

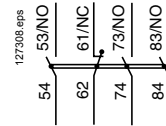

Instantaneous auxiliary contacts conforming to standard EN 50012 (References: page 10)

1 N/O + 1 N/C LAD N11G

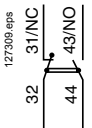

1 N/O + 1 N/C LAD N11P

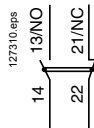

2 N/O + 2 N/C LAD N22G

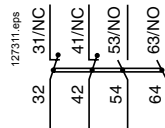

2 N/O + 2 N/C LAD N22P

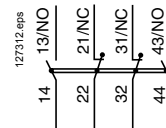

3 N/O + 1 N/C LAD N31G

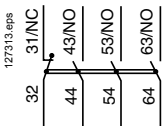

3 N/O + 1 N/C LAD N31P

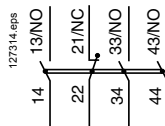

1 N/O + 3 N/C LAD N13G

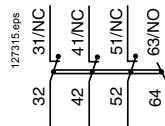

1 N/O + 3 N/C LAD N13P

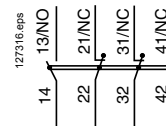

(1) Items in brackets refer to blocks mounted on right-hand side of contactor.

TeSys D Green

Contactors with AC/DC coil

Front mounting add-on contact blocks

Dust and damp protected instantaneous auxiliary contacts (References: page 10)

2 N/O (24-50 V) LA1 DX20	2 N/C (24-50 V) LA1 DX02	2 N/O (5-24 V) LA1 DY20	2 N/O protected (24-50 V) 2 N/O standard LA1 DZ40	2 N/O protected (24-50 V) + 1 N/O + 1 N/C standard LA1 DZ31
-----------------------------	-----------------------------	----------------------------	---------------------------------------------------------	----------------------------------------------------------------

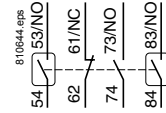
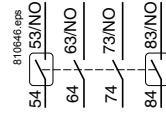
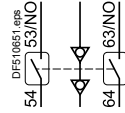
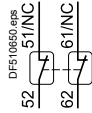
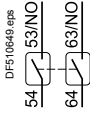

Time delay auxiliary contacts (References: page 11)

On-delay 1 N/O + 1 N/C LAD T	Off-delay 1 N/O + 1 N/C LAD R	On-delay 1 N/C + 1 N/O break before make LAD S
---------------------------------	----------------------------------	---------------------------------------------------

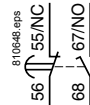
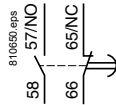
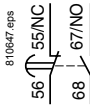

Mechanical latch blocks (References: page 11)

LAD 6K10 and LA6 DK20

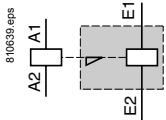

Side mounting add-on contact blocks

Instantaneous auxiliary contacts (References: page 10)

1 N/O + 1 N/C LAD 8N11 ⁽¹⁾	2 N/O LAD 8N20 ⁽¹⁾	2 N/O LAD 8N02 ⁽¹⁾
---------------------------------------	-------------------------------	-------------------------------

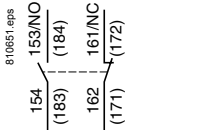

⁽¹⁾ Items in brackets refer to blocks mounted on right-hand side of contactor.

Electronic serial timer modules

On-delay LA4 DT•U

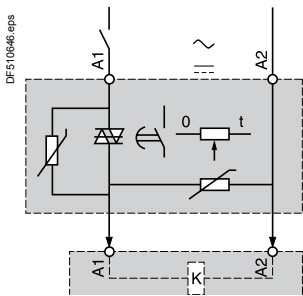

Interface modules

Solid state

LA4 DWB

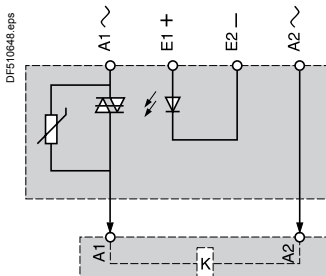

Dimensions

TeSys D Green

Reversing contactors with electronic coil

LC2 D09 to D38 with electronic coil - composed of 2 x LC1D09 to D38 (3-pole)

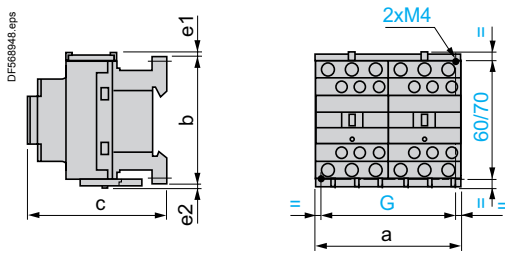

	a	b	c ⁽¹⁾	e1	e2	G
D09 to D18	90	77	86	4	1.5	80
D25 to D38	90	85	92	9	5	80

e1 and e2: including cabling.

⁽¹⁾ With safety cover, without add-on block.

LC2 D40A to D80A with electronic coil - composed of 2 x LC1D40A to D80A (3-pole)

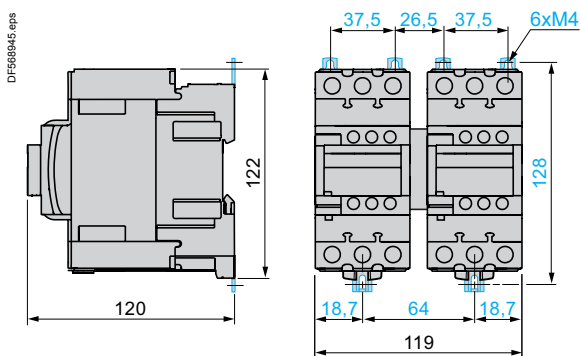

TeSys D Green

Reversing contactors with AC/DC coil

Reversing contactors for motor control

LC2 D09...D80A

Horizontally mounted

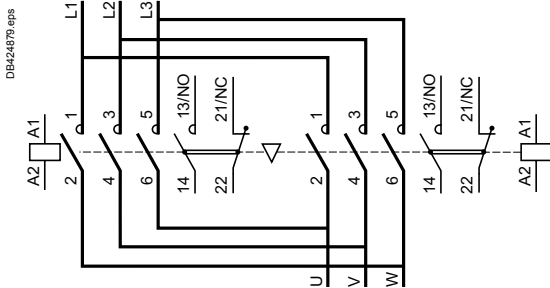

LAD 9R1V

With integral electrical interlocking

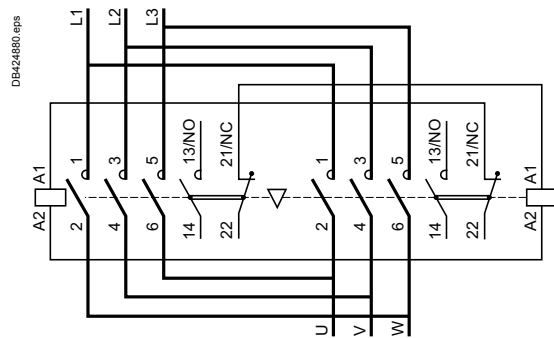

Electrical interlocking of reversing contactors fitted with:

Mechanical interlock with integral electrical contacts

LA9 D4002, LA9 D8002 and LA9 D11502

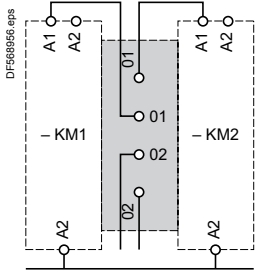

Mechanical interlock without integral electrical contacts

LAD 9V2, LAD 4CM, LA9 D50978 and LA9 D80978

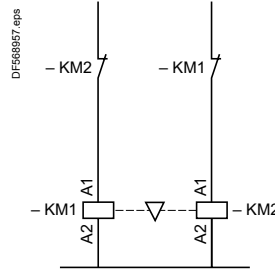

Low speed - High speed cabling kit, screw clamp terminals

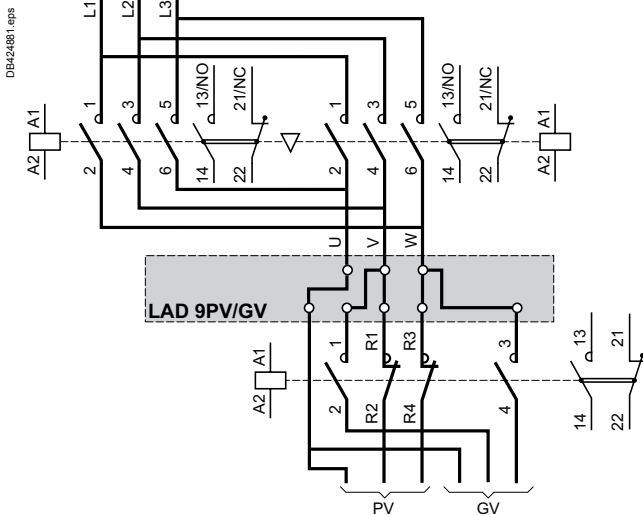

Low speed - High speed cabling kit, spring terminals

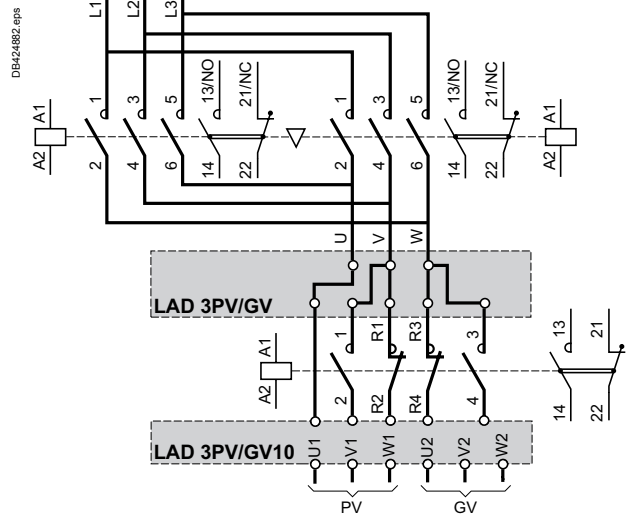

Notes

Notes

Life Is On



Schneider Electric Industries SAS

35, rue Joseph Monier
CS 30323
92506 Rueil Malmaison Cedex
France

RCS Nanterre 954 503 439
Capital social 896 313 776 €
www.schneider-electric.com

November 2016
LVCATESDGR-EN

© 2016- Schneider Electric. All Rights Reserved.
All trademarks are owned by Schneider Electric Industries SAS or its affiliated companies.

This document has been
printed on recycled paper